



Version 6.0
English

Leica RX1200

User Manual

- when it has to be **right**

Leica
Geosystems

Introduction

Purchase

Congratulations on the purchase of an RX1200.



This manual contains important safety directions as well as instructions for setting up the product and operating it. Refer to "7 Safety Directions" for further information. Read carefully through the User Manual before you switch on the product.

Product identification





The type and serial number of your product are indicated on the type plate. Enter the type and serial number in your manual and always refer to this information when you need to contact your agency or Leica Geosystems authorized service workshop.

Type: _____

Serial No.: _____

Symbols

The symbols used in this manual have the following meanings:

Type	Description
 Danger	Indicates an imminently hazardous situation which, if not avoided, will result in death or serious injury.
 Warning	Indicates a potentially hazardous situation or an unintended use which, if not avoided, could result in death or serious injury.
 Caution	Indicates a potentially hazardous situation or an unintended use which, if not avoided, may result in minor or moderate injury and/or appreciable material, financial and environmental damage.
	Important paragraphs which must be adhered to in practice as they enable the product to be used in a technically correct and efficient manner.



Trademarks



- Windows and Windows CE are a registered trademark of Microsoft Corporation
 - CompactFlash and CF are trademarks of SanDisk Corporation
 - Bluetooth is a registered trademark of Bluetooth SIG, Inc
- All other trademarks are the property of their respective owners.

Validity of this manual

This manual applies to all RX controllers. Differences between the various models are marked and described.

Available documentation

Name	Description/Format of RX1200 manuals		
User Manual	All instructions required in order to operate the product to a basic level are contained in the User Manual. Provides an overview of the product together with technical data and safety directions.	✓	✓

Name	Description/Format of GPS1200/TPS1200+/TPS1200 manuals		
System Field Manual	Describes the general working of the product in standard use. Intended as a quick reference field guide.		✓
Applications Field Manual	Describes specific onboard application programs in standard use. Intended as a quick reference field guide.	✓	✓
Technical Reference Manual	Overall comprehensive guide to the product and program functions. Included are detailed descriptions of special software/hardware settings and software/hardware functions intended for technical specialists.		✓

Refer to the following resources for all System1200 documentation/software:

- the SmartWorx DVD
 - <http://www.leica-geosystems.com/downloads>
-

Table of Contents

In this manual

Chapter	Page
1 Description of the System	12
1.1 Terminology	12
1.2 System Concept	15
1.2.1 Software Concept	15
1.2.2 Data Storage and Data Conversion Concept	19
1.2.3 Power Concept	21
1.3 Container Contents	22
1.4 RX Components	24
2 User Interface	26
2.1 Keyboard	26
2.2 Screen	30
2.3 Operating Principles	32
2.4 Icons	33

3	Setting up the Equipment	38
3.1	Equipment Setup	38
3.1.1	Fixing the RX to a Holder and Pole	38
3.1.2	Fixing the RX to a Handstrap	43
3.1.3	Fixing the RX to a GNSS Receiver	44
3.1.4	Setting up for Remote Control (with the RadioHandle)	46
3.1.5	Setting up for Remote Control (with the TCPS27)	47
3.1.6	Setting up SmartPole	49
3.1.7	Setting up a Real-Time Reference	51
3.1.8	Setting up SmartRover	52
3.2	Batteries	54
3.2.1	Operating Principles	54
3.2.2	Battery for all RX1250 models	56
3.2.3	Battery for SmartAntenna	58
3.2.4	Battery for GHT56	60
3.3	Working with the CompactFlash Card	62
3.4	LED Indicators on SmartAntenna	66
3.5	LED Indicators on GHT56	68
3.6	Working with the Clip-On-Housings for Devices on GHT56	70
3.7	Guidelines for Correct Results with GNSS Surveys	81

4	Getting Started with SmartWorx	82
4.1	Overview	82
4.2	Turning on the RX, setting the Instrument Mode and Interface	83
4.3	Understanding the Main Menu	87
4.4	Switching Between GPS and TPS	89
4.5	Working with Licence Keys	92
4.6	Connecting to a Digital Cellular Phone	96
4.7	Connecting to the Disto	98
4.8	Connecting to a Personal Computer	101
4.9	Connecting to a Radio (for Remote Control Surveys)	107
4.9.1	Available Radios	107
4.9.2	Working in Remote Mode	108
4.9.3	Working in Transparent Mode	109
4.9.4	Working in Semi-Transparent Mode	110
4.10	Connecting to the SmartAntenna	111

5	Local Mode	114
<hr/>		
5.1	Accessing the Main Configuration Menu	114
5.2	Overview of the Main Configuration Menu	115
5.3	Choosing a Sensor	116
5.4	Local Settings	117
5.5	Radio Settings	121
	5.5.1 Radio Communication Settings	121
	5.5.2 Configuring the Radios	126
5.6	Working with a Sensor	128
6	Care and Transport	130
<hr/>		
6.1	Transport	130
6.2	Storage	131
6.3	Cleaning and Drying	132

7	Safety Directions	134
7.1	General Introduction	134
7.2	Intended Use	135
7.3	Limits of Use	137
7.4	Responsibilities	138
7.5	End User Licence Agreement EULA	140
7.6	Hazards of Use	143
7.7	Electromagnetic Compatibility EMC	149
7.8	FCC Statement, Applicable in U.S.	152
8	Trouble Shooting	160

9	Technical Data	168
9.1	RX Technical Data	168
9.2	SmartAntenna Technical Data	174
9.2.1	Tracking Characteristics	174
9.2.2	Accuracy	177
9.2.3	Technical Data	178
9.3	GHT56 Technical Data	182
9.4	Conformity to National Regulations	185
9.4.1	RX1210	185
9.4.2	RX1250, GFU23	186
9.4.3	GFU24, Siemens MC75	188
9.4.4	GFU19 (US), GFU25 (CAN), GFU26 (US) CDMA MultiTech MTMMC-C	190
9.4.5	SmartAntenna with Bluetooth	192
10	International Limited Warranty, Software Licence Agreement	194
	Appendix A Directory Structure of the Memory Device	196
	Appendix B Cables	198
	Index	202

1 Description of the System

1.1 Terminology

Abbreviations

The following abbreviations may be found in this manual:

Term	Description
GNSS	G lobal N avigation S atellite S ystem (generic term for satellite based navigation systems like GPS, GLONASS, SBAS)
LGO	LEICA G eo O ffice (office software consisting of a suite of standard and extended programs for the viewing, exchange and management of data)
RCS	R emote C ontrol S urveying
TPS	T otal Station P ositioning S ystem

RX general description

Type	Description
RX or RX1200	This is a collective term describing the various models of the multi-purpose controller which is used with GPS and TPS instruments.

RX
available models

Model	Touch screen	Display-monochrome	Display-colour	Internal radio modem	Internal battery	CompactFlash card	Bluetooth	Windows CE	Recommended for ...
RX1210		✓							GPS1200 GX Receiver
RX1210T	✓	✓							GPS1200 GX Receiver
RX1250T	✓	✓		✓	✓	✓	✓	✓	TPS1200+/TPS1200 instruments
RX1250Tc	✓		✓	✓	✓	✓	✓	✓	TPS1200+/TPS1200 instruments
RX1250X	✓	✓			✓	✓	✓	✓	GPS1200 SmartRover
RX1250Xc	✓		✓		✓	✓	✓	✓	GPS1200 SmartRover
 Use the supplied stylus on the screens of the touch screen models.									

**RX
available radios****Radios for remote control (RCS) are found in the following devices:**

Radio Modem	Description
GFU23	Clip-on-Housing with an integrated radio modem and attached radio antenna.
RadioHandle	Instrument carry handle with an integrated radio modem and attached radio antenna.
RX1250T	Controller with an integrated radio modem and attached radio antenna. This controller has a monochrome display.
RX1250Tc	Controller with an integrated radio modem and attached radio antenna. This controller has a colour display.
TCPS27	External radio modem with attached radio antenna.
TCPS27B	TCPS27 set to operate as a base radio.
TCPS27R	TCPS27 set to operate as a remote radio.
	All devices contain the same spread spectrum transceiver radio modem.

1.2 System Concept

1.2.1 Software Concept

Software for RX1210/RX1210T

Software type	Description
RX firmware (RX1200.fw)	<p>These RX models are used as terminals and only one software is required to be installed. All other necessary software is loaded onto the GPS/TPS.</p> <p>This software includes all the local display, sound and communication settings. These settings can only be changed by putting the RX into local mode.</p>

Software for all RX1250 models

Software type	Description
RX firmware (RX1250_xx.fw)	<p>These RX models can be used as data loggers or terminals. The same amount of software is required to be installed as for the GPS/TPS. This software includes:</p> <ul style="list-style-type: none">- The local display, sound and communication settings.- The language specific version of Windows CE.- The basic functionality of the RX.

Software type	Description
	<ul style="list-style-type: none">- The programs Survey and Wake-Up (for GPS) and Survey and Setup (for TPS), which cannot be deleted.- The English language, which cannot be deleted.
Language software (SYS_LANG.sxx)	<p>Numerous languages are available for the RX. Language software is also referred to as system language.</p> <p>The system software enables a maximum of three languages which can be stored at any one time - the English language and two other languages. The English language is the default language and cannot be deleted. One language is chosen as the active language.</p>
Application programs (RX_program.axx)	<p>A suite of optional survey-specific application programs are available for the instrument.</p> <p>Some of these programs are freely available and can be loaded and are immediately activated. The other programs must be purchased and are only activated with a licence key.</p>

Software type	Description
Customised application programs	Custom software specific to user requirements can be developed using the GeoC++ development kit. Information on the GeoC++ development environment is available on request from a Leica Geosystems representative.

Software for the SmartAntenna

Software type	Description
SmartAntenna software	This is the software for the ATX1230 GG. It covers the firmware for the measurement engine.

Software upload

Software for	Description
RX1210/RX1210T	<p>This firmware can be uploaded to RX via LGO, TPS1200+/TPS1200 or GPS1200.</p> <p>If TPS1200+ is being used, refer to the TPS1200+ Technical Reference Manual.</p> <p>If TPS1200 is being used, refer to the TPS1200 Technical Reference Manual.</p>

Software for	Description
	<p>If GPS1200 is being used, refer to the GPS1200 Technical Reference Manual.</p> <p>If LGO is being used, refer to the online help in LGO.</p>
All RX1250 models	<p>All software is stored in the System RAM of the RX. The software can be uploaded onto a CompactFlash card in the RX.</p> <p>After uploading, the software must then be transferred from the CompactFlash card to the RX System RAM. Refer to GPS1200/TPS1200+/TPS1200 Technical Reference Manuals for further details.</p> <p>Microsoft ActiveSync is the synchronization software for Windows mobile-based pocket PC's. Microsoft ActiveSync enables a PC and a Windows mobile-based pocket PC to communicate.</p>
SmartAntenna	<p>SmartAntenna must always be connected to an RX1250 model when uploading the firmware. Connect SmartAntenna and an RX1250 model via cable. Uploading the firmware takes some time.</p>

1.2.2 Data Storage and Data Conversion Concept

Description

Data is stored within a job in a database on a memory device.
The memory device can be a CompactFlash card or internal memory.

Memory device

CompactFlash card: A CompactFlash card slot is standard. A CompactFlash card can be inserted and removed. Available capacity: 256 MB.



Whilst other CompactFlash cards may be used, Leica recommends to only use Leica CompactFlash cards and is not responsible for data loss or any other error that may occur whilst using a non-Leica card.



Unplugging connecting cables or removing the CompactFlash card during the measurement may cause loss of data. Always return to the Main Menu screen before removing the CompactFlash card and switch off the instrument before removing cables.

Data conversion**Export**

Data can be exported from a job in a wide range of ASCII formats. The export format is defined in Format Manager which is a PC tool in LEICA Geo Office. Refer to the online help of LGO for information on creating format files.

Data can also be exported from a job in DXF or LandXML format.

Import

Data can be imported from ASCII, DXF, GSI8 or GSI16 format.

Transfer data

Data can be transferred in various ways. Refer to "ActiveSync" and LGO online help.



CompactFlash cards can directly be used in an OMNI drive as supplied by Leica Geosystems. Other PC card drives may require an adaptor.

1.2.3 Power Concept

General

Use the Leica Geosystems batteries, chargers and accessories or accessories recommended by Leica Geosystems to ensure the correct functionality of the instrument.

Power options

Model	Power supply
RX1210/RX1210T	Via cable, or Via clip-on connector of the GPS receiver, or Externally via cable
all RX1250 models	Internally via GEB211 battery, or Externally via cable If an external power supply is connected and one internal battery is inserted, then the external power is used.
SmartAntenna	Internally via GEB211 battery, or Externally via cable If an external power supply is connected and one internal battery is inserted, then the external power is used.

1.3 Container Contents

Container for
System 1200
components
part 1 of 2

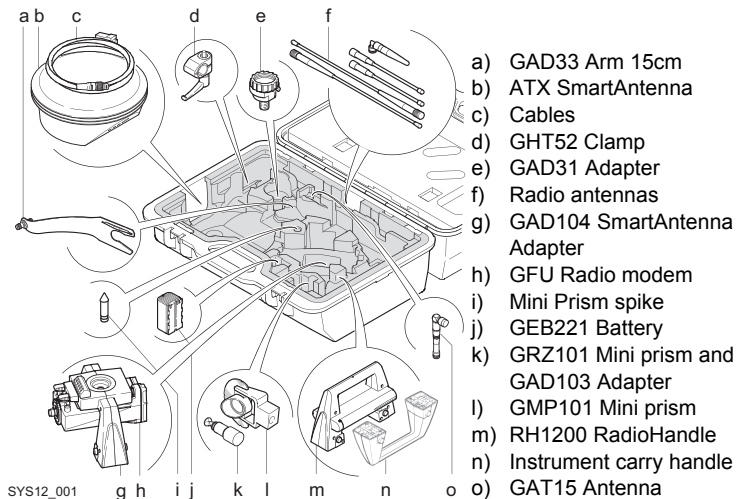

**Container for
System 1200
components
part 2 of 2**

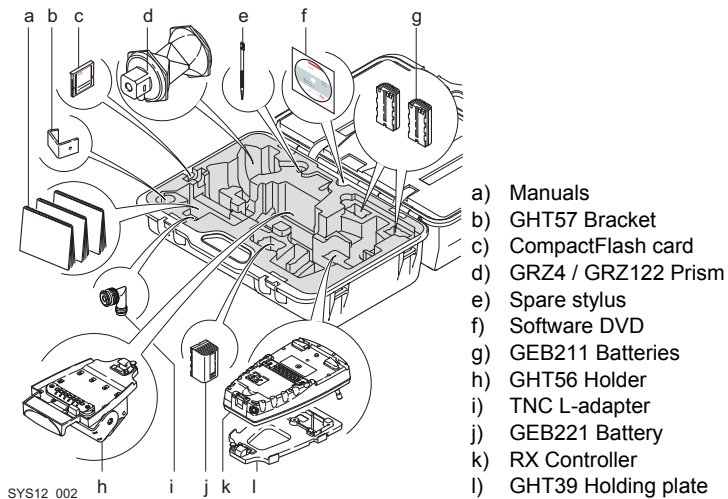

1.4 RX Components

Upperside of RX

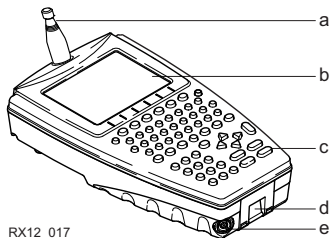

RX12_017

- a) For RX1250T/RX1250Tc: Radio antenna
- b) Screen
- c) Keyboard
- d) Hand strap bottom clips
- e) LEMO port: for RX1250 including USB port

Underside of RX

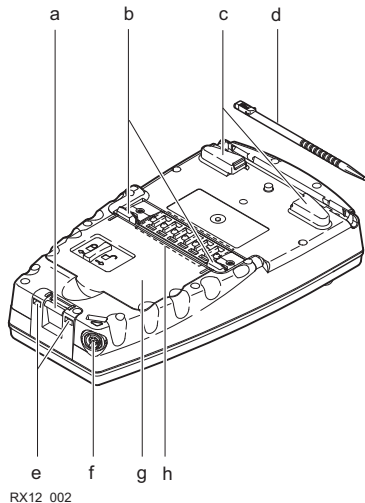

- a) Bottom spring clip for pole holder
- b) Top clips for pole holder
- c) Hand strap top clips
- d) Stylus
- e) Hand strap bottom clips
- f) LEMO port
For RX1250 including USB port
- g) Battery compartment
For RX1250 with CompactFlash card compartment
- h) Clip-on-contacts

For RX1250, a Bluetooth port is included inside to facilitate connectivity to the SmartAntenna, digital cellular phone or Leica Disto™.

2 User Interface

2.1 Keyboard

Keyboard display

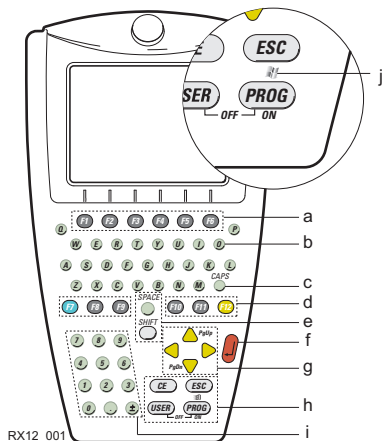

- a) Function keys **F1-F6**
- b) Alpha keys
- c) **CAPS**
- d) Hot keys **F7-F12**
- e) **SPACE, SHIFT**
- f) **ENTER**
- g) Arrow keys
- h) **CE, ESC, USER, PROG**
- i) Numeric keys
- j) For all RX1250 models:
Windows key symbol. It is the Microsoft flag logo located between **PROG** and **ESC**.





For the purpose of the illustration, a RX1250 model has been selected which is representative for all models. Differences to other RX models are outlined.

Keys

Key	Function
Function keys F1-F6	Correspond to six softkeys that appear on the bottom of the screen when the screen is activated.
Hot keys F7-F12	User definable keys to execute chosen commands or access chosen screens.
Alpha keys	To type letters.
Numeric keys	To type numbers.
CAPS	Switches between upper case and lower case letters.
CE	Clears all entry at the beginning of user input. Clears the last character during user input.
ESC	Leaves the current screen without storing any changes. In SmartWorx mode and in the Main Menu: Turns RX off when held for 2 s. In Terminal mode: Turns RX off when held for 2 s

Key	Function
PROG (ON)	If RX is already off: Turns RX on. If RX is already on: Accesses the Programs menu.
SHIFT	Switches between the first and second level of function keys.
SPACE	Enters a blank.
USER	In SmartWorx mode: Calls the user defined menu. In Terminal mode: Hold down for 2 s to open the Main Configuration Menu.
Arrow keys	Move the focus on the screen.
ENTER	Selects the highlighted line and leads to the next logical menu / dialog. Starts the edit mode for edit fields. Opens a choicelist.

Key combinations

Key	Function
PROG plus USER	In SmartWorx mode and in the Main Menu: Turns RX off when pressed simultaneously. In Terminal mode: Turns RX off when pressed simultaneously.
SHIFT 	Pages up.
SHIFT 	Pages down.
SHIFT PROG ()	For all RX1250 models: Displays the Windows desktop, task bar and start menu.
USER STAT (F3)	Opens the Status Menu.

2.2 Screen

Screen

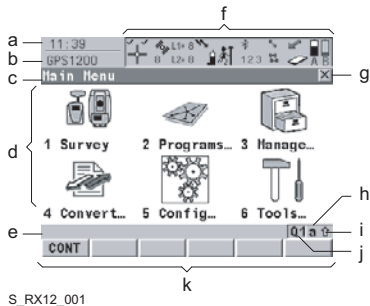

- a) Time
- b) Caption
- c) Title
- d) Screen area
- e) Message line
- f) Icons
- g) ESC ☒
- h) CAPS
- i) SHIFT icon
- j) Quick coding icon
- k) Softkeys

Elements

Type	Description
Time	The current local time is shown.
Caption	Shows location either in Main Menu, under PROG key or USER key.
Title	Name of the screen is shown.

Type	Description
Screen area	The working area of the screen.
Message line	Messages are shown for 10 s.
Icons	Shows current status information of the instrument. Can be used with touch screen to access the subsequent screen.
ESC ☒	Can be used with touch screen. Same functionality as the ESC fixed key. The last operation will be undone.
CAPS	The caps mode for upper case letters is active. The caps mode is activated and deactivated by pressing UPPER (F5) or LOWER (F5) in some screens.
SHIFT icon	Shows the status of the SHIFT key; either first or second level of softkeys is selected. Can be used with touch screen and has the same functionality as the fixed key SHIFT .
Quick coding icon	Shows the quick coding configuration. Can be used with touch screen to turn quick coding on and off.
Softkeys	Commands can be executed using F1 - F6 keys. The commands assigned to the softkeys are screen dependent. Can be used directly with touch screen.

2.3 Operating Principles

Keyboard and touch screen

The user interface is operated either by the keyboard or by the touch screen with supplied stylus. The workflow is the same for keyboard and touch screen entry, the only difference lies in the way information is selected and entered.

Operation by keyboard

Information is selected and entered using the keys. Refer to "2.1 Keyboard" for a detailed description of the keys on the keyboard and their function.

Operation by touch screen

Information is selected and entered on the screen using the supplied stylus.

Operation	Description
To select an item	Tap on the item.
To start the edit mode in input fields	Tap on the input field.
To highlight an item or parts of it for editing	Drag the supplied stylus from the left to the right.
To accept data entered into an input field and exit the edit mode	Tap on the screen outside of the input field.

2.4 Icons



Description

For a complete listing of icons

- for GPS1200 refer to GPS1200 System Field Manual.
- for TPS1200+ refer to TPS1200+ System Field Manual.
- for TPS1200 refer to TPS1200 System Field Manual.

Battery icons





The power status (indicated by six levels) and source of the battery is displayed. Tapping the icon leads to **STATUS Battery & Memory, Battery**.

Icon	Description
	Internal battery is in use
	External battery attached and in use
	For TPS1200+/TPS1200 instruments: Internal TPS and RX battery are in use

Icon	Description
	For TPS1200+/TPS1200 instruments: External TPS and RX battery are in use

Bluetooth icons

The status of each Bluetooth port and any Bluetooth connection is displayed. Tapping the icon leads to **STATUS Bluetooth**.

Icon	Description
	All RX1250 models are integrated with Bluetooth
	A Bluetooth connection is established and active
	Bluetooth connection not established. Bluetooth port 1,2,3 are down
	Bluetooth connection established. Bluetooth port 1,2,3 are active

Full Switch icon in GPS instrument mode

The following icon appears only in the Main Menu.

Icon	Description
	Tapping the icon leads to Instrument Mode Selection , which allows a full switch from GPS instrument mode to TPS instrument mode. Refer to "4.4 Switching Between GPS and TPS" for further details.

Full Switch icon in TPS instrument mode

The following icon appears only in the Main Menu.







Icon	Description
	Tapping the icon leads to Instrument Mode Selection , which allows a full switch from TPS instrument mode to GPS instrument mode. Refer to "4.4 Switching Between GPS and TPS" for further details.

Quick Switch icons in TPS instrument mode

The following icons appear only in the Survey program.

Refer to "4.4 Switching Between GPS and TPS" for further details.



Icon	Description
	Tapping the icon leads to GPS Survey. The icon displays the current status of the GPS position and is represented by the following:

Icon	Description
	No connection to the SmartAntenna
	Active connection to the SmartAntenna - navigated solution
	Active connection to the SmartAntenna - code solution
	Active connection to the SmartAntenna - fixed solution
Tapping the icon leads to TPS Survey. The icon displays the current status of the instrument connection and is represented by the following:	
	No connection to the instrument
	Active connection to the instrument
	Active connection to the instrument - Searching for prism

Interface icons in TPS instrument mode

Icon	Description
	Active connection to the instrument - Locked onto prism

Tapping the icon leads to **Configure Interfaces**. The icon displays the current status of the radio connection to the instrument and is represented by the following:

Icon	Description
	No radio connection to the instrument
	Active radio connection to the instrument

3 Setting up the Equipment

3.1 Equipment Setup

3.1.1 Fixing the RX to a Holder and Pole

Components of the GHT39 holder

The GHT39 holder consists of a number of components, as shown in the diagram.

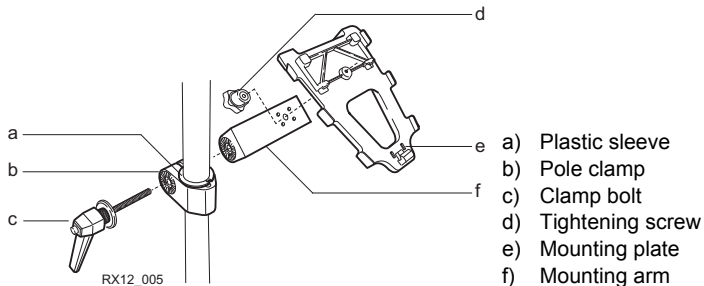

Components of the GHT56 holder

The GHT56 holder consists of a number of components, as shown in the diagram.

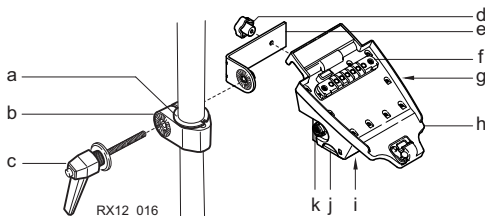

GHT52 clamp



- a) Plastic sleeve
- b) Pole clamp
- c) Clamp bolt

GHT56 holder

- d) Tightening screw
- e) Mounting arm
- f) Clip-on-contacts for connecting RX1250
- g) LED
- h) Mounting plate
- i) Battery compartment
- j) Locking mechanism for battery
- k) Space for clip-on-housing with LEMO port

Fixing the RX and GHT39 holder to a pole step-by-step

	Description
1.	Remove holder from the travel container.
2.	A plastic sleeve may be required to be fitted to the pole clamp.

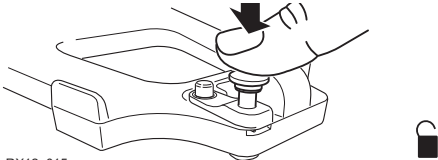
	Description
3.	Insert pole into the clamp hole.
4.	Adjust the angle of the mounting plate and the height of the holder on the pole to comfort.
5.	<p data-bbox="426 296 966 332">Tighten the clamp with the tightening screw.</p> <p data-bbox="426 337 1373 420"> Once tightened, the button on the tightening screw can be depressed to change the position of the handle for more comfort.</p> <p data-bbox="426 425 1373 498"> A locking mechanism is incorporated in the mounting plate of the holder.</p>
6.	<p data-bbox="426 510 1373 614">Before RX is placed onto the mounting plate ensure that the locking pin is put into the unlocked position. To unlock the locking pin, push down the red button situated on top of the mounting plate.</p> <div data-bbox="426 635 994 842"><p data-bbox="426 837 513 852">RX12_015</p></div>
7.	Hold RX above the holder and lower the end into the holder.

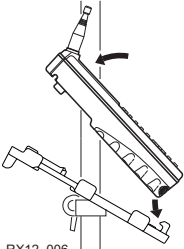
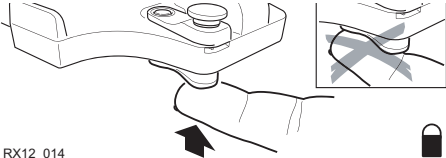
	Description
8.	<p>Apply slight pressure in a downward direction and then lower the top part of RX until the unit is clicked into the holder. The guides of the holder aid in this action.</p>  <p>RX12_006</p>
9.	<p>After RX is placed onto the mounting plate ensure that the locking pin is put into the locked position. To lock the locking pin, push up the red button from below.</p>  <p>RX12_014</p>

**Detaching the RX
from a pole step-
by-step**

Description	
1.	Unlock the locking pin by pushing down the red button situated on top of the mounting plate.
2.	Place the palm over the top of RX until the fingers grip the bar of the holder under the top of RX.
3.	Compress the top of RX toward the bar of the holder.
4.	While in this position, raise the top of RX where the palm is gripping the unit up from the holder.

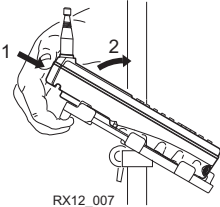

RX12_007

3.1.2 Fixing the RX to a Handstrap

Fixing the RX to a Handstrap step-by-step

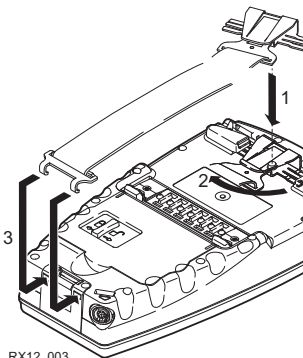
	Description	
1.	Hold the main hook rotated to approximately the 11 o'clock position in relation to RX.	 <p>RX12_003</p>
2.	Lower the main hook onto the pivot knob in the middle of RX.	
3.	Rotate the main hook to the 12 o'clock position. A click should be felt when the clip is secure.	
4.	Take the other end of the handstrap and clip it to the base of RX.	

3.1.3 Fixing the RX to a GNSS Receiver

Fixing the RX to GNSS receiver step-by-step

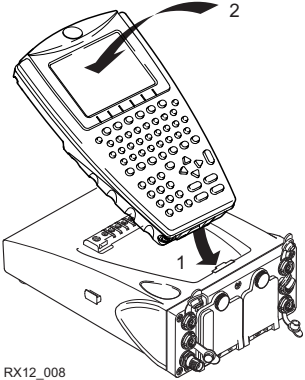
	Description	
1.	Hold RX above the recess in the housing of the GNSS receiver intended for the unit.	 <p data-bbox="976 733 1059 754">RX12_008</p>
2.	Lower the bottom part of RX into the recess in the housing of the GNSS receiver.	
3.	Apply slight pressure in a downward direction and then lower the top part of RX until the unit is clicked into the GNSS receiver. The recess in the housing of the GNSS receiver helps to guide RX.	

**Detaching the RX
from GNSS
receiver step-by-
step**

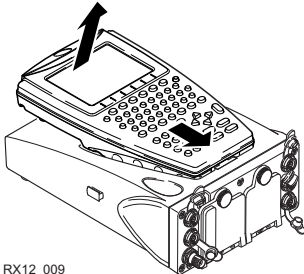
	Description	
1.	Place the palm over the top of RX.	 <p>RX12_009</p>
2.	Compress RX downward toward the ports of the GNSS receiver.	
3.	While in this position, raise the top of RX from the GNSS receiver.	

3.1.4 Setting up for Remote Control (with the RadioHandle)

TPS1200+/TPS1200 /RX1200 setup for RCS with Radio- Handle

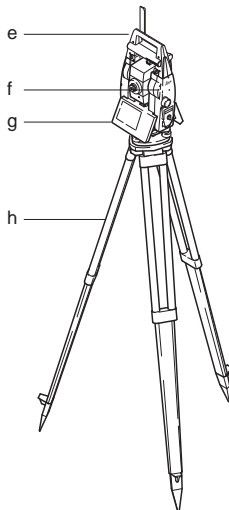
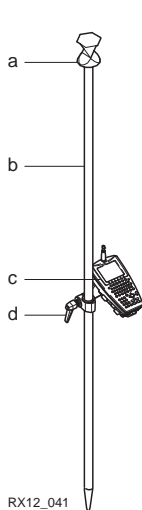

- a) 360° prism
- b) Prism pole
- c) RX1250T/RX1250Tc
- d) RX holder and pole clamp
- e) RH1200 RadioHandle
- f) Communication side cover
- g) TPS1200+/TPS1200 instrument
- h) Tripod

Refer to TPS1200+/TPS1200 User Manual for further details on the RadioHandle.

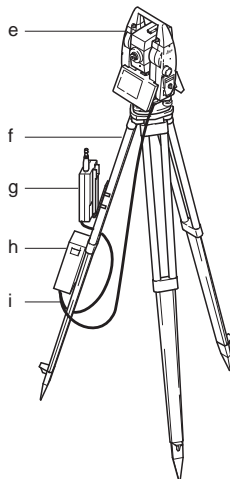
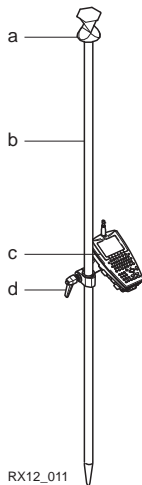

3.1.5 Setting up for Remote Control (with the TCPS27)

TPS1200+/TPS1200
/RX1200 setup for
RCS with TCPS27



- a) 360° prism
- b) Prism pole
- c) RX1250T/RX1250Tc
- d) RX holder and pole clamp
- e) TPS1200+/TPS1200 instrument
- f) Tripod
- g) TCPS27B
- h) External battery
- i) Y-cable

**Mount base radio
to tripod
step-by-step**

	Description
1.	The GHT43 tripod adapter is used to mount TCPS27B to all Leica standard tripods, in order to optimise the radio transmission performance. Attach TCPS27B to the adapter and then attach to the tripod leg.
2.	Adjust the angle of TCPS27B until it is approximately vertical.
3.	Adjust the location of the adapter on the tripod leg so that there are no metallic objects in the horizontal plane around the antenna.  Metallic objects near the antenna disturb radio transmissions.
4.	 To achieve the best performance from TCPS27B, it should be mounted in a vertical position on the tripod leg approximately 30 cm from the top of the tripod.  If the adapter is no longer able to retain it's angle position, the adjustment bolt at the hinge can be slightly tightened.

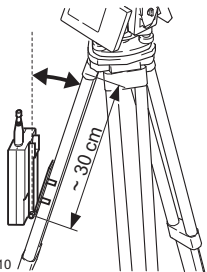

RX12_010

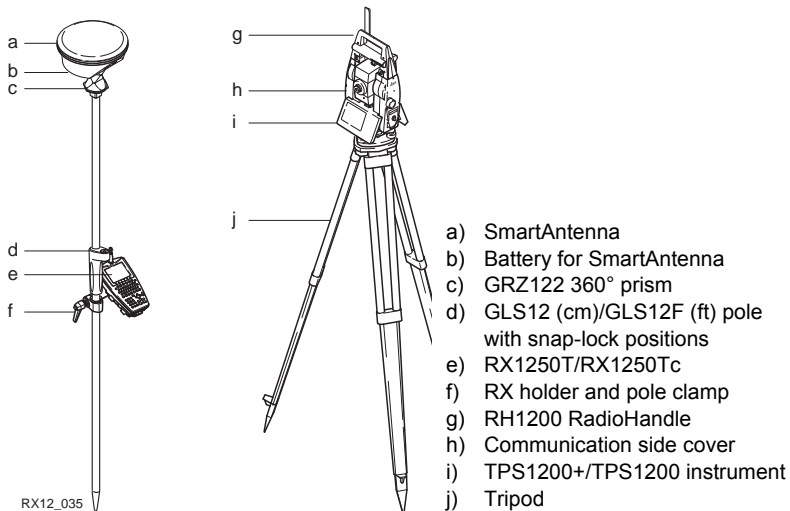

3.1.6 Setting up SmartPole

SmartPole setup



Understanding the reflector/antenna heights with the GLS12/GLS12F pole

The GLS12 (cm)/GLS12F (ft) telescopic pole has fixed equally spaced snap-lock positions. The scale readings along the pole relate to the height of the reflector (prism centre). Two additional positions, clearly marked with diagrams on the pole, relate to the SmartAntenna. The snap-lock must always click into position.

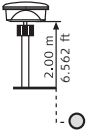
Snap-lock positions	Diagram on pole
1. Use only these snap-lock positions for measurements with: GRZ4 360° prism or GRZ122 360° prism or circular prism Reflector Height (prism centre) = height reading on pole	
2. Use only this snap-lock position for measurements with: SmartAntenna and the GRZ122 360° prism Antenna Height (MRP) = 2.00 m/6.562 ft Reflector Height (prism centre) = 1.941 m/6.368 ft The height difference between: SmartAntenna(MRP) - Reflector(prism centre) = 5.90 cm/0.194 ft	
3. Use only this snap-lock position for measurements with: SmartAntenna and the GAD31 screw to stub adapter Antenna Height (MRP) = 2.00 m/6.562 ft	

3.1.7 Setting up a Real-Time Reference

Description

Two setups for RX1250 are given as example. Refer to GPS1200 Technical Reference Manual for information on additional setups.

SmartAntenna/ RX1250X setup for real-time reference

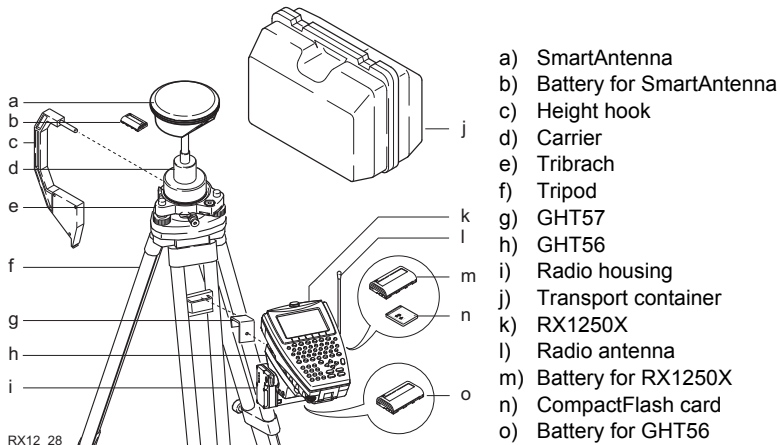

3.1.8 Setting up SmartRover

SmartRover setup with external radio

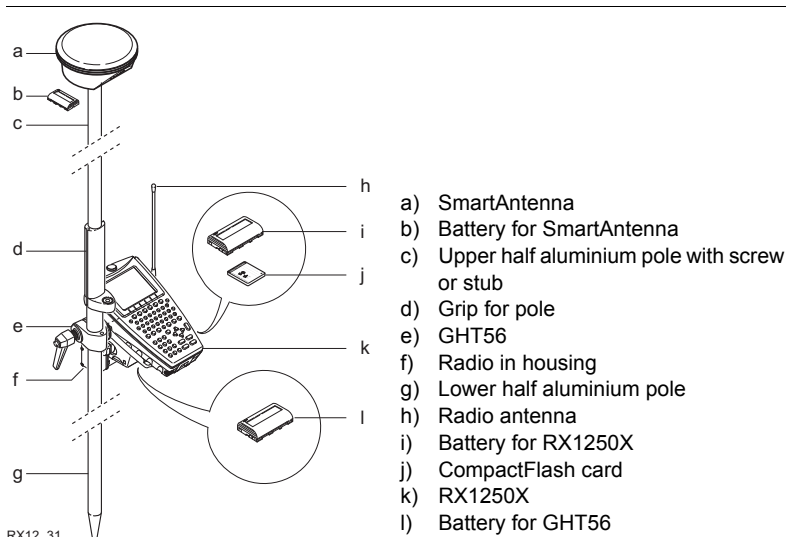

Increase radio coverage on Smart-Rover

Description

Some applications require the maximum radio coverage. In those cases the radio antenna is mounted on an antenna arm which is fixed to the pole just below the SmartAntenna. Connection is made between the radio housing and the radio antenna.

Connect radio antenna and radio housing using cable step-by-step

	Description
1.	Clip the antenna arm to the SmartAntenna.
2.	Screw the radio antenna onto the antenna arm.
3.	Attach the radio in its housing to GHT56.
4.	Place the battery into the battery compartment of the GHT56.
5.	Attach GHT56 to the pole and tighten the screw.
6.	Connect the radio antenna to the radio housing using the 1.2 m antenna cable.

3.2 Batteries

3.2.1 Operating Principles



This chapter is valid for all RX1250 models and GHT56.



Primary use/charging

- The battery must be charged prior to using it for the first time because it is delivered with an energy content as low as possible.
- For new batteries or batteries that have been stored for a long time (> three months), it is effectual to make only one charge/discharge cycle.
- For Li-Ion batteries, a single discharging and charging cycle is sufficient. We recommend carrying out the process when the battery capacity indicated on the charger or on a Leica Geosystems product deviates significantly from the actual battery capacity available.
- The permissible temperature range for charging is between 0°C to +40°C/ +32°F to +104°F. For optimal charging we recommend charging the batteries at a low ambient temperature of +10°C to +20°C/+50°F to +68°F if possible.
- It is normal for the battery to become warm during charging. Using the chargers recommended by Leica Geosystems, it is not possible to charge the battery if the temperature is too high.

Operation/Discharging

- The batteries can be operated from -20°C to $+55^{\circ}\text{C}$ / -4°F to $+131^{\circ}\text{F}$.
 - Low operating temperatures reduce the capacity that can be drawn; very high operating temperatures reduce the service life of the battery.
-

3.2.2 Battery for all RX1250 models

Change battery
step-by-step

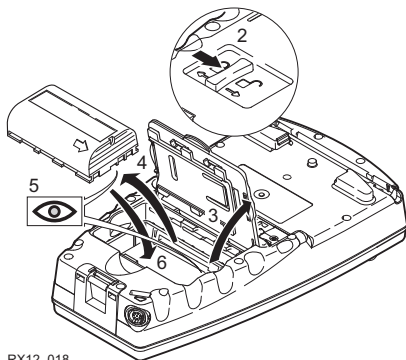

RX12_018

	Description
1.	Turn RX over to gain access to the battery compartment.
2.	Push the slide fastener in the direction of the arrow with the open-lock symbol.
3.	Open the battery compartment.

	Description
4.	Pull the battery from the battery compartment.
5.	A pictogram of the battery is displayed inside the battery compartment. This is a visual aid to assist in placing the battery correctly.
6.	Place the battery into the battery compartment with the Leica logo facing to the left.
7.	Close the battery compartment by pushing the slide fastener in the direction of the arrow with the close-lock symbol.

3.2.3 Battery for SmartAntenna

Change battery step-by-step

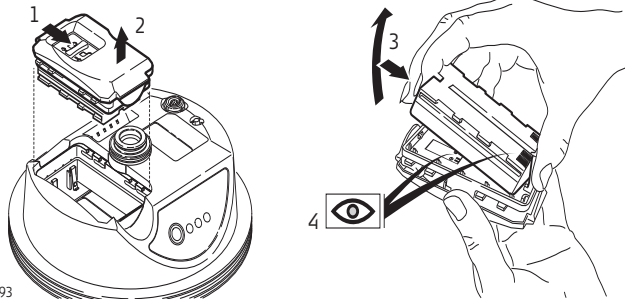

TPS12_193

	Description
1.	 Turn SmartAntenna over to gain access to the battery compartment. Open the battery compartment by pushing the slide fastener in the direction of the arrow with the open-lock symbol.
2.	Pull out the battery housing. The battery is attached to the housing.
3.	Hold the battery housing and pull the battery from the battery housing.



	Description
4.	A polarity of the battery is displayed inside the battery housing. This is a visual aid to assist in placing the battery correctly.
5.	Place the battery onto the battery housing, ensuring that the contacts are facing outward. Click the battery into position.
6.	Close the battery compartment by pushing the slide fastener in the direction of the arrow with the close-lock symbol.

3.2.4 Battery for GHT56

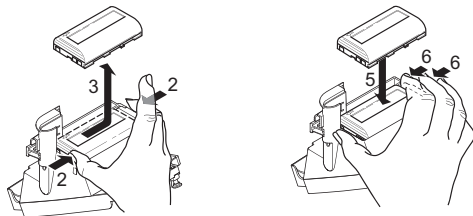
Change battery step-by-step



RX12_022

	Description
1.	Turn GHT56 over to gain access to the battery compartment.
2.	Press simultaneously on the right side of the locking mechanism and the left side of the battery.
	 This unlocks the battery from its locked position.
3.	Pull the battery from the battery compartment.
4.	Place the battery into the battery compartment.
	 Ensure that the battery is placed adjacent to the locking mechanism with the contacts facing down.

	Description
5.	Press simultaneously on the right side of the locking mechanism and the right side of the battery.
	This locks the battery into position.



GEB211 and GEB221 can both be used with GHT56. The battery powers a device in a clip-on-housing attached to the GHT56.

3.3 Working with the CompactFlash Card



This chapter is only valid for all RX1250 models.



- Keep the card dry.
 - Use it only within the specified temperature range.
 - Do not bend the card.
 - Protect the card from direct impacts.
-



Failure to follow these instructions could result in data loss and/or permanent damage to the card.

Insert and remove a CompactFlash card step-by-step

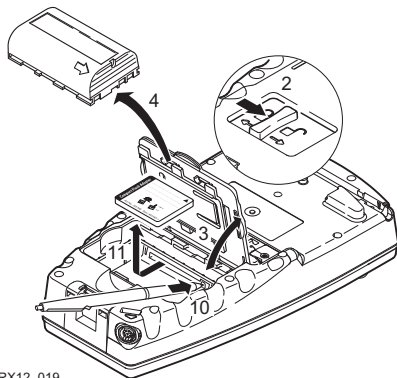



RX12_019

	Description
1.	The CompactFlash card is inserted into a slot inside the battery compartment. Turn RX over to gain access to the battery compartment.
2.	Push the slide fastener in the direction of the arrow with the open-lock symbol.
3.	Open the battery compartment.

	Description
4.	Pull the battery from the battery compartment.
5.	 The card should be held with the label for the care instructions upwards and the contacts facing the slot.
	Slide the card firmly into the slot until it clicks into position.
6.	Place the battery into the battery compartment.
7.	Close the compartment cover.
8.	To remove the card, open the cover of the battery compartment.
9.	Pull the battery from the battery compartment.
10.	Press the eject button on the right side of the card slot twice.
11.	Pull out the CompactFlash card.
12.	Close the compartment cover.

Format a Compact-Flash card step-by-step

Formatting the CompactFlash card before logging data is started is required if a completely new CompactFlash card is used or if all existing data needs to be deleted.

	Description
1.	Select Main Menu: Tools...\Format Memory Device.
2.	<p>TOOLS Format Memory Device</p> <p><Memory Device: CF Card></p> <p><Format Method: Format Quick></p> <p>Select the memory device to be formatted.</p> <p> By activating the format command all data will be lost. Make sure that all important data on the CompactFlash card has been backed up before formatting the card. Before formatting the internal memory make sure that all important data is first transferred to the PC.</p> <p> To exit the screen without formatting the memory device, press ESC. This returns to the previous screen.</p>
3.	CONT (F1)
4.	<p>YES (F4) to continue with the formatting of the selected device.</p> <p> NO (F6) to not continue with the formatting of the selected device and to return to TOOLS Format Memory Device.</p>

3.4 LED Indicators on SmartAntenna

LED indicators

Description

SmartAntenna has Light Emitting Diode indicators. They indicate the basic antenna status.

Diagram

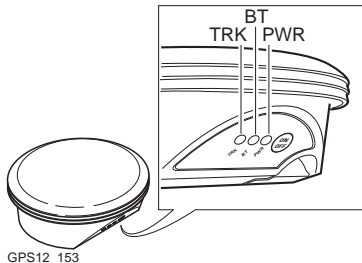

TRK	Tracking LED
BT	Bluetooth LED
PWR	Power LED

Description of the LED's

IF the	is	THEN
TRK	off	no satellites are tracked.
	flashing green	less than four satellites are tracked, a position is not yet available.
	green	enough satellites are tracked to compute a position.
	red	SmartAntenna is initialising.
BT	green	Bluetooth is in data mode and ready for connecting.
	purple	Bluetooth is connecting.
	blue	Bluetooth has connected.
	flashing blue	data is being transferred
PWR	off	power is off.
	green	power is okay.
	flashing green	power is low. The remaining time for which enough power is available depends on the type of survey, the temperature and the age of the battery.
	red	power is very low. The battery should be changed.

3.5 LED Indicators on GHT56

LED indicator

Description

GHT56 has one Light Emitting Diode indicator. It indicates the basic power status.

Diagram

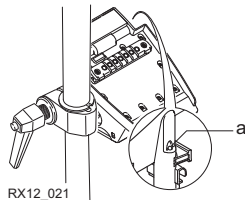

a) Power LED

Description of the LED

IF the	is	THEN
PWR	off	power is off.
	green	power is okay.
	flashing green	power is low. The remaining time for which enough power is available depends on the type of survey, the temperature and the age of the battery.
	red	power is very low. The battery should be changed.

3.6 Working with the Clip-On-Housings for Devices on GHT56

Devices fitting into a clip-on-housing

Digital cellular phones for GPS RTK fitting into a clip-on-housing

Digital cellular phone	Clip-on-housing
Siemens MC75	GFU24
CDMA MultiTech MTMMC-C (US)	GFU19, GFU26
CDMA MultiTech MTMMC-C (CAN)	GFU25

Radios for GPS RTK fitting into a clip-on-housing

Radio	Clip-on-housing
Pacific Crest PDL, receive	GFU15
Satellite 3AS, transceive	GFU14

Radios for Remote Control fitting into a clip-on-housing

Radio	Clip-on-housing
spread spectrum transceiver	GFU23

Attach a clip-on-housing step-by-step

The clip-on-housing for devices fits to the underside of the GHT56.

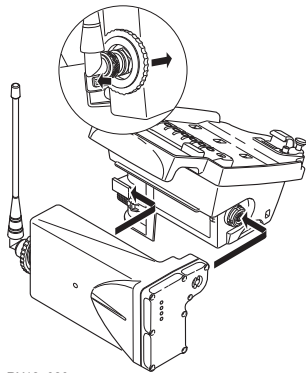

RX12_020

Description	
1.	 A circular screw is located at one end of the clip-on-housing. Ensure that the circular screw is in the unlocked position. Turn it anticlockwise, as shown by the lock and arrow symbols on the screw.

	Description
	Turn GHT56 over to gain access to the space for the clip-on-housing.
2.	Place the clip-on-housing into position such that <ul style="list-style-type: none"> • the guide rails on the GHT56 are aligned with the guide rails on the clip-on-housing. AND <ul style="list-style-type: none"> • the LEMO port on the GHT56 is aligned with the connector on the clip-on-housing.
3.	Slide the clip-on-housing into position such that the connector is completely plugged into the LEMO port. It clicks.
	 Do not turn the screw on the topside of the clip-on-housing. The clip-on-housing is automatically fixed when completely plugged into position.

Detach a clip-on-housing step-by-step

	Description
1.	Press the small press clip next to the guide rail on the GHT56 to unlock the clip-on-housing from the GHT56.
2.	Slide the clip-on-housing away from the press clip until the connector is completely unplugged from the LEMO port.

	Description
3.	Pull the clip-on-housing from the GHT56.

Insert a SIM card step-by-step

For those digital cellular phones that require SIM cards.

	Description
1.	Take the SIM card, a coin and a pen.
2.	Locate the SIM card screw, that covers the SIM card slot, on the bottom of the clip-on-housing.
3.	Insert the coin into the groove of the SIM card screw.
4.	Turn the coin anticlockwise to loosen the SIM card screw.
5.	Remove the SIM card screw from the housing.
6.	Using the pen, press the small button of the SIM card slot to eject the SIM card holder.
7.	Take the SIM card holder out off the housing.
8.	Put the SIM card into the SIM card holder, the chip facing up.
9.	Insert the SIM card holder into the SIM card slot, the chip facing the connectors inside the slot.

	Description
10.	Place the SIM card screw back on the housing.
11.	Insert the coin into the groove of the SIM card screw.
12.	Turn the coin clockwise to tighten the SIM card screw.

Remove a SIM card step-by-step

For those digital cellular phones that require SIM cards.

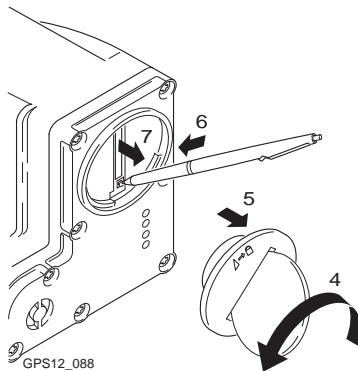

	Description
1.	Take a coin and a pen.
2.	Locate the SIM card screw, that covers the SIM card slot, on the bottom of the clip-on-housing.
3.	Insert the coin into the groove of the SIM card screw.

	Description
4.	Turn the coin anticlockwise to loosen the SIM card screw.
5.	Remove the SIM card screw from the housing.
6.	Using the pen, press the small button of the SIM card slot to eject the SIM card holder.
7.	Take the SIM card holder out off the SIM card slot.
8.	Take the SIM card out of the SIM card holder.
9.	Put the SIM card holder back into the SIM card slot, the even side not facing the contacts inside the slot.
10.	Place the SIM card screw back on the housing.
11.	Turn the coin clockwise to tighten the SIM card screw.

LED indicators

Description

Each clip-on-housing for a radio, digital cellular phones or Bluetooth communication has **Light Emitting Diode** indicators on the bottom side. They indicate the basic device status.

Diagram

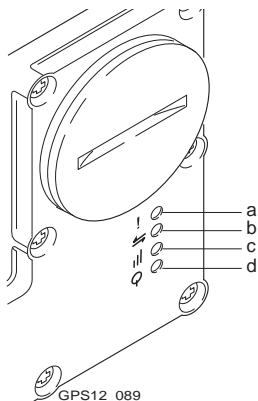

- a) Configuration LED
- b) Data Transfer LED
- c) Signal Strength LED
- d) Power LED

Description of the LED's

IF the	on	is	THEN
Config LED	GFU14 with Sateline 3AS, GFU23	red	the device is in the configuration mode controlled from the PC via cable.
Data transfer LED	any device	off	data is not being transferred.
		green or flashing green	data is being transferred.
Signal strength LED	GFU19 (US), GFU25 (CAN), GFU26 (US) with CDMA MultiTech MTMMC-C	red	device is on, not registered on the network.
		flashing red	device is on, registered on the network.
		off	download mode or device is off.
	GFU23	off	no radio link to remote controller.
		red	radio link to remote controller.

IF the	on	is	THEN
GFU24 with Siemens MC75		red	call is in progress.
		red: long flash, long break	no SIM card inserted, no PIN entered or network search, user authentication or network login in progress.
		red: short flash, long break	logged onto network, no call in progress.
		red: flashing red, long break	GPRS PDP context activated.
		red: long flash, short break	Packet switched data transfer is in progress.
		off	device is off.
GFU15 with Pacific Crest PDL		red or flashing red	the communication link, Data Carrier Detection , is okay on the roving receiver.
		off	the DCD is not okay.

IF the	on	is	THEN
	GFU14 with Satellite 3AS	red or flashing red	the communication link, Data Carrier Detection , is okay on the roving receiver.
		off	the DCD is not okay.
Power LED	any device	off	power is off.
		green	power is okay.

3.7 Guidelines for Correct Results with GNSS Surveys

Undisturbed satellite signal reception

Successful GNSS surveys require undisturbed satellite signal reception, especially at the receiver which serves as a reference. Set up the receivers in locations which are free of obstructions such as trees, buildings or mountains.

Steady antenna for static surveys

For static surveys, the antenna must be kept perfectly steady throughout the whole occupation of a point. Put the antenna on a tripod or pillar.



Centred and levelled antenna

Centre and level the antenna precisely over the marker.

4 Getting Started with SmartWorx

4.1 Overview



Choosing the correct program on the Windows CE Desktop



Data Storage	Instrument			
	TPS1200+/ TPS1200	GPS1200 GX Receiver	GPS1200 SmartRover	TPS1200+/ TPS1200
Store data on CF Card in GPS/TPS instrument	✓	✓		
Store data on CF Card in RX controller			✓	✓
Program	 System1200 Terminal		 SmartWorx	
	To use the RX as a terminal		To use the RX as a data logger	

4.2 Turning on the RX, setting the Instrument Mode and Interface

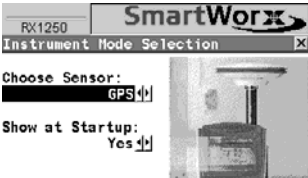
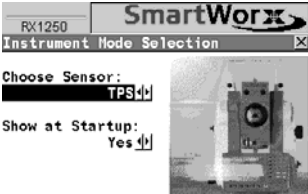
Turning the RX on step-by-step

	Description	
1.	<p>Ensure that the RX has a power supply. Press PROG (ON) on the keyboard.</p> <p>For RX1210/RX1210T, the RX will automatically turn on if it is connected via cable or via clip-on connector to GPS/TPS which is already on.</p>	
2.	<p>For all RX1250 models, the Windows desktop is the default display after starting up.</p> <p>To use the RX as a terminal: Double click on the Terminal icon.</p> <p>To use the RX as a data logger: Double click on the SmartWorx icon.</p>	 <p>The image shows a 3x3 grid of desktop icons. The top row contains 'My Device' (a mobile phone), 'Internet Explorer' (the globe icon), and 'SmartWorx' (a starburst icon). The middle row contains 'Recycle Bin' (a trash can), 'Microsoft WordPad' (a document with a pencil), and 'System1200 Terminal' (a calculator icon). The bottom row contains three smaller icons: a folder, a document, and a terminal window.</p>

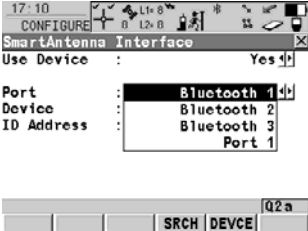
	Description	
3.	<p>For SmartWorx, the Instrument Mode Selection screen is displayed by default. To connect the RX to GPS, select Choose Sensor=GPS. To show this screen the next time the RX is turned on, select Show at Startup=Yes.</p>	 <p>The screenshot shows the SmartWorx Instrument Mode Selection screen. At the top, it says 'RX1250' and 'SmartWorx'. Below that is the title 'Instrument Mode Selection'. The 'Choose Sensor:' field is set to 'GPS'. The 'Show at Startup:' field is set to 'Yes'. A small image of the RX1200 device is visible on the right side of the screen.</p>
	<p>For SmartWorx, the Instrument Mode Selection screen is displayed by default. To connect the RX to TPS, select Choose Sensor=TPS. To show this screen the next time the RX is turned on, select Show at Startup=Yes.</p>	 <p>The screenshot shows the SmartWorx Instrument Mode Selection screen. At the top, it says 'RX1250' and 'SmartWorx'. Below that is the title 'Instrument Mode Selection'. The 'Choose Sensor:' field is set to 'TPS'. The 'Show at Startup:' field is set to 'Yes'. A small image of the RX1200 device is visible on the right side of the screen.</p>
4.	<p>Configuring the interface. For GPS, press CONF (F2) to go to the Configure SmartAntenna Interface screen. For TPS, press CONF (F2) to go to the Configure Instrument Interface screen.</p>	 <p>The screenshot shows the bottom portion of the SmartWorx interface. It features a row of function keys: 'CONT', 'CONF', and several empty keys. In the top right corner, there is a small icon and the text 'Q2 a ↑'.</p>

	Description	
	<p>Setting the SmartAntenna Interface. Turn on the SmartAntenna. Set Use Device=Yes. Select a free Bluetooth port. Press DEVICE (F5) to open a list of devices. Select the SmartAntenna. Press SRCH (F4) to search and establish a data connection to the SmartAntenna.</p>	
	<p>Setting the Instrument Interface. For RX1250T/RX1250Tc: Set the instrument interface to: Port=Internal Radio, Device=Int. Radio. For TPS with RadioHandle: Set the GeoCom interface to: Port=Port 2(Handle), Device=RH1200.</p>	
5.	Press CONT (F1) to go to the Main Menu.	



Setting the interface between the RX and the connecting device can always be set later. From the Main Menu select Config/ Interfaces.

Turning the RX off

Option	Description
Turning the RX off	The RX can only be turned off in the Main Menu screen or in the Windows CE desktop. Press USER and PROG simultaneously, or Press and hold ESC for 2 s.
Unplugging the RX or unclipping the RX from the GPS/TPS	Disconnecting either the LEMO cable or the clip-on connector of the RX without an internal battery automatically switches it off.
Auto power down	Option to set shutdown and sleep events after user defined duration of instrument inactivity when working with TPS.

4.3 Understanding the Main Menu

The Main Menu

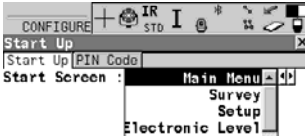
	Description	
1.	<p>By default, the Main Menu is the first screen shown after starting up from the Windows desktop.</p> <p>To set another screen for the start up: Select Config from the Main Menu, Select General Settings, Select Start Up, Select the Start Up page,</p>	
2.	<p>Select a start screen from the choicelist, Press CONT (F1) to go to the Main Menu.</p>	

Main Menu icons





Refer to "2.4 Icons" for a list and description of all available icons in the Main Menu.

Main Menu keys

Description	
To select the highlighted menu function and continue	CONT (F1)
To select another sensor - switching between GPS and TPS	SHIFT MODE (F2)
To put the RX into sleep mode. In sleep mode, the RX shuts down and reduces power. The sleep mode is designed to preserve energy. Rebooting the RX from sleep mode is quicker than a cold start after turning off.	SHIFT SLEEP (F3)
To minimise SmartWorx and to display the Windows desktop	SHIFT MINIM (F5)
To quit and close SmartWorx	SHIFT EXIT (F6)
For all RX1250 models: To display the Windows desktop, task bar and start menu.	SHIFT PROG

4.4 Switching Between GPS and TPS

Full switching step-by-step

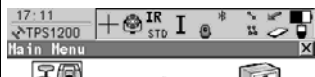
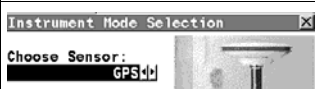
To switch from GPS instrument mode to TPS instrument mode:	
1.	Option 1: Click on the TPS icon  , or Option 2: Press SHIFT MODE (F2). 
2.	Select Choose Sensor=TPS. Press CONT (F1) to go to the TPS1200+/TPS1200 Main Menu. 
To switch from TPS instrument mode to GPS instrument mode:	
1.	Option 1: Click on the GPS icon  , or Option 2: Press SHIFT MODE (F2). 
2.	Select Choose Sensor=GPS. Press CONT (F1) to go to the GPS1200 Main Menu. 
<p>Full switching is available only in the Main Menu screen. Full switching does not require a licence.</p>	

Switching in survey step-by-step

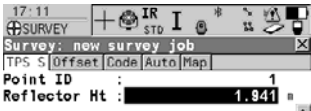
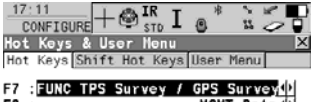
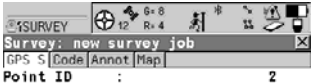
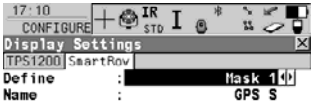
To switch between TPS Survey and GPS Survey during Survey:	
1.	<p>From TPS Survey: Option 1: Click on the GPS icon, or</p>  <p>Option 2: Configure and assign a hot key: Select Config from the Main Menu, Select General Settings, Select Hot Keys & User Menu</p> 
2.	<p>From GPS Survey: Option 1: Click on the TPS icon, or Option 2: Press the configured hot key.</p> 
	<p>The display masks are user configured: Select Config from the Main Menu, Select Survey Settings, Select Display Settings.</p> 
Switching in Survey is available only in TPS mode.	

Switching in setup step-by-step

To switch to GPS Survey during Setup:		
1.	Select the setup method.	
2.	Press GPS (F4) to access GPS Survey.	
3.	The measured GPS point is stored to the Fixpoint Job. This point can be used as a control point in TPS Setup. The display masks are user configured.	
Switching in Setup (for SmartPole) is available only in TPS mode.		

4.5 Working with Licence Keys

Remote Licensing

It is possible to temporarily transfer a program licence from TPS1200+/TPS1200 onto any of the RX1250 models. This procedure would only make sense when the RX is to be used as a data logger.

Available programs RX1210/RX1210T

For these models, only the RX firmware file is loaded. All programs are loaded onto the GPS/TPS. Refer to "1.2.1 Software Concept" for further details.

Available programs all RX1250 models

For these models, a one program/one licence concept has been established. That is, it is only necessary to load one file for each program and to activate one licence. The program can be loaded in either GPS mode or TPS mode. Once loaded, the program is available to both GPS and TPS (except TPS specific programs). A program can also be removed from either GPS or TPS mode.

Available programs	Licence Key
Alignment Tool Kit	
Cogo	
Determine Coordinate System	✓
DXF Export	✓
LandXML Export	✓

Available programs	Licence Key
DXF Import	
Hidden Point (for TPS only)	✓
RoadRunner	✓
Reference Line	✓
Reference Plane	✓
Stakeout	
Volume Calculations	✓
Sets of Angles (for TPS only)	✓
Survey Cross Section	✓
Traverse (for TPS only)	✓



Protected options

Protected option	Licence Key
licence - SmartPole	✓
licence - GPS Survey Functionality	✓
option - Cogo (Area Division)	✓
option - Extended OWI messages	✓

Protected option	Licence Key
option - GLONASS permanent option	✓

Activating a licence

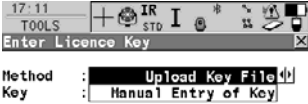

	Description	
1.	To enter a licence key or upload a licence key file: Select Tools from the Main Menu, Select Licence Keys from the Tools Menu.	 <p>The screenshot shows the top status bar of the TPS1200 device with the time 17:11 and various icons. Below it is the 'Tools Menu' which is open, displaying a list of options: 1 Format Memory Device, 2 Transfer Objects..., 3 Upload System Files..., 4 Calculator, 5 File Viewer, and 6 Licence Keys. The '6 Licence Keys' option is highlighted with a black background.</p>

	Description	
2.	<p>Upload Key File: Upload the key file from the CompactFlash card. The key file must be stored in the \SYSTEM directory on the CompactFlash card. Licence key files use the naming convention L_123456.key, where 123456 is the instrument serial number.</p>	
3.	<p>Manual Entry of Key: Type the key in manually.</p>	
4.	<p>An optional step is to delete all licence keys. Press SHIFT DEL (F4).</p>	
5.	<p>Press CONT (F1) to go to the Main Menu.</p>	

4.6 Connecting to a Digital Cellular Phone

Connecting step-by-step

	Description
1.	Select Main Menu: Config...\Interfaces... in the Leica software.
2.	Highlight Real-Time .
3.	EDIT (F3)
4.	CONFIGURE Real-Time Mode <R-Time Mode: Rover> Select a free Bluetooth port.
5.	DEVCE (F5)
6.	CONFIGURE Devices, Modems/GSM page Highlight a Bluetooth capable digital cellular phone.
7.	CONT (F1)
8.	SRCH (F4) to search for the digital cellular phone.  The digital cellular phone must be turned on and Bluetooth must be activated.
9.	CONFIGURE Search Bluetooth Device

	Description	
	All available Bluetooth devices are displayed.	
10.	Highlight the digital cellular phone to be used.	
11.	CONT (F1)	
		If the digital cellular phone selected is connected for the first time, the Windows CE dialog for pairing comes up. Type in 0000 as identification number for Leica's Bluetooth and click OK .
		Some digital cellular phones also ask for the identification number for Leica's Bluetooth. The number is 0000.
		Some digital cellular phones also ask for an acknowledgement before connecting to another Bluetooth device.

4.7 Connecting to the Disto

Connecting step-by-step

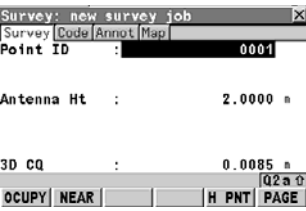
	Description	
1.	Turn on the Disto. Press the Bluetooth key to activate Bluetooth. The Bluetooth icon will display on the Disto screen and will continue to blink until there is a successful data connection to the RX. Bluetooth will switch off on the Disto if the connection is not established within 240 sec.	 <p>The image shows the Leica DISTO™ A6 screen with a Bluetooth icon and an 'ON DIST' button.</p>
2.	Ensure that the RX is in GPS mode. Go to the Survey program and to the Survey Begin screen. Enter the appropriate information and press CONT (F1) to continue to the Survey screen. Ensure that the Survey page is active. Press H PNT (F5) to continue to the Hidden Point Measurement screen.	 <p>The image shows the Survey program screen with fields for Point ID (0001), Antenna Ht (2.0000 m), and 3D CQ (0.0085 m). The bottom of the screen shows navigation buttons: OCUPY, NEAR, H PNT, and PAGE.</p>

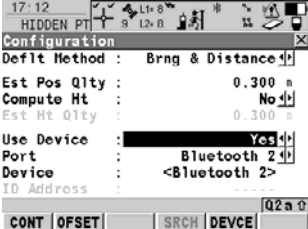
	Description	
3.	Press SHIFT CONF (F2) to enter the Configuration screen.	
4.	Set <Use Device: Yes> . Select a free Bluetooth port. Press DEVCE (F5) to open a list, displaying Bluetooth capable devices. From the list, highlight and select the Disto and return to the configuration screen. Press SRCH (F4) to search for Bluetooth devices. Select the Disto device from the list of Bluetooth devices found and return to the configuration screen. Press CONT (F1) to establish the data connection.	

	Description	
5.	Measure the required distance with the Disto. For Disto A4/A5, press and activate the 2nd key. Then press the Bluetooth key to send the measurement to the RX. For Disto A6 it is sufficient to press the Bluetooth key. The distance will be sent and displayed on the RX screen.	 <p>The screenshot shows the RX1200 receiver screen. At the top, it displays the time '17:12' and 'HIDDEN PT'. Below this, a title bar reads 'Hidden Point Measurement'. The main display area shows the following data:</p> <ul style="list-style-type: none">Method : Brng & DistancePoint : house cornerAzimuth : 0.0000 gHoriz Dist : 5.325 m

4.8 Connecting to a Personal Computer

ActiveSync

Microsoft ActiveSync is the synchronization software for Windows mobile-based pocket PC's. ActiveSync enables a PC and a Windows mobile-based pocket PC, like the RX1250, to communicate.



ActiveSync is freeware. It can be downloaded from the Microsoft website.

Connect USB cable to PC for the first time step-by-step



	Description
1.	Start the PC.
2.	Have the SmartWorx DVD version 5.0 or higher ready.
3.	Plug the GEV161 cable into RX1250.
4.	Turn the RX1250 on.
5.	Wait until the Windows CE desktop is visible.
6.	Plug the GEV161 cable into the USB port of the PC.
	 The new hardware wizard starts up automatically.
7.	Tick No, not at this time .
8.	Next> .
9.	Tick Install from a list or specific location (Advanced) .

	Description
10.	Next> .
11.	Insert the SmartWorx DVD version 5.0 or higher.
12.	Tick Search removable media (floppy, CD-ROM...) .
13.	Next> .
14.	Confirm Hardware Installation window with Continue Anyway .
15.	Finish .
16.	Run the ActiveSync installation program if not already installed.
17.	Allow USB connections inside the Connection Settings window of Active-Sync.
18.	Is LGO used? If yes , continue with step 6. in paragraph "Connect to LGO via USB cable step-by-step". Is no , continue with step 6. in paragraph "Connect to PC via USB cable step-by-step".

**Connect to LGO via
USB cable
step-by-step**



	Description
1.	Start the PC.
2.	Plug the GEV161 cable into RX1250.
3.	Turn the RX1250 on.
4.	Plug the GEV161 cable into the USB port of the PC.  ActiveSync starts up automatically. If does not start automatically, start ActiveSync. If not already installed, run the ActiveSync installation program.
5.	Allow USB connections inside the Connection Settings window of Active-Sync.
6.	Start LGO or install it if not available.
7.	Start the Leica SmartRover software on the RX1250.
8.	Goto Data Exchange Manager in LGO.
9.	Click Refresh on the ActiveSync folder.
10.	Establish the communication to RX1250.  The folders CF-Card, System1200 and Sensor System are displayed in the Data Exchange Manager.

**Connect to PC via
USB cable
step-by-step**

	Description
1.	Start the PC.
2.	Plug the GEV161 cable into RX1250.
3.	Turn the RX1250 on.
4.	Plug the GEV161 cable into the USB port of the PC.
	 ActiveSync starts up automatically. If does not start automatically, start ActiveSync. If not already installed, run the ActiveSync installation program.
5.	Allow USB connections inside the Connection Settings window of ActiveSync.
6.	Click on Explore in ActiveSync.
	 The folders on the RX1250 are displayed under Mobile Devices . The folders of the CompactFlash can be found in StorageCard .

Via Bluetooth step-by-step



	Description
1.	Activate Bluetooth on the PC. The steps required depend on the Bluetooth driver and other PC specific configurations. On the PC, always ensure that <ul style="list-style-type: none">• the correct COM port is defined.• the COM port is configured as incoming, which allows Bluetooth devices to detect the PC.
2.	Turn the RX1250 on.
3.	Go to Start/Settings/Control Panel/Bluetooth Device .
4.	Click Scan Device .
5.	Highlight the service required in the Untrusted box.
6.	Click - -> to move the service to the Trusted box.
7.	Highlight the service required in the Trusted box.
8.	Right mouse click to access the context menu.
9.	Tick Active .
	 Go to Start/Settings/Control/System/Device Name to give the RX1250 a specific name.

	Description
10.	Go to Start/Settings/Control Panel/PC Connection .
11.	Select Bluetooth from the combo box.
12.	Go to Start/Programs/Communication/ActiveSync to initialise the communication.
	 As soon as the communication is initialised on the RX1250, ActiveSync establishes the link between the PC and RX1250.
13.	Start LGO or install it if not available.
14.	Goto Data Exchange Manager in LGO.
15.	Click Refresh on the ActiveSync folder.
16.	Establish the communication to RX1250.
	 The folders CF-Card, System1200 and Sensor System are displayed in the Data Exchange Manager.

4.9 Connecting to a Radio (for Remote Control Surveys)

4.9.1 Available Radios

Connections



Radio modem	Port	
Internal radio of RX1250T/RX1250Tc	Internal Radio	
GFU23 attached to any RX1250 model via GHT56	Clip-on	
TCPS27 attached to any RX1250 model via cable	Port 1	
RadioHandle attached on top of TPS	Port 2 (Handle)	
GFU23 attached to TPS via cable	Port 1	
TCPS27 attached to TPS via cable	Port 1	

4.9.2 Working in Remote Mode

Description

In the remote mode TPS is controlled from RX. To work in this mode TPS must be set to RCS mode. Refer to TPS1200+/TPS1200 Technical Reference Manual for more information. While in RCS mode TPS can still be controlled with the keys on the instrument.

Access step-by-step



	Description
1.	 Proceed to the local menu of RX. Select Main Configuration Menu: Radio/Comms Settings, Modes page.
2.	Set <ComMode: RCS Mode> .
	 <ComMode: RCS Mode> is set automatically when turning on RX.

4.9.3 Working in Transparent Mode

Description

<ComMode: Transparent> enables the remote control of TPS with GeoCOM commands. RX becomes a transparent radio modem, like the RadioHandle or TCPS27B. GeoCOM commands can be sent from a computer to RX which are then sent to TPS via RadioHandle or TCPS27B. These commands will be executed on TPS and results can be sent back.

Access step-by-step

	Description
1.	 From CONFIGURE Interfaces on TPS ensure that GeoCOM Mode is turned on and RCS Mode is turned off.
	 Proceed to the local menu of RX.
	Select Main Configuration Menu: Radio/Comms Settings, Modes page.
2.	Set <ComMode: Transparent> .

4.9.4 Working in Semi-Transparent Mode

Description

<**ComMode: Semi-Transparent**> enables the total remote control of TPS in RCS mode but the data being captured by TPS will be sent via radio link to the LEMO port of RX. A computer connected to this port will receive the data captured on TPS in real-time.



Data being sent over the radio link in this mode is not protected by a Leica protocol. There exists a chance of data loss without notification.



Access step-by-step

	Description
	From CONFIGURE Interfaces on TPS ensure that GSI Output and RCS Mode are turned on.
	Proceed to the local menu of RX.
1.	Select Main Configuration Menu: Radio/Comms Settings, Modes page.
2.	Set < ComMode: Semi-Transparent >.

4.10 Connecting to the SmartAntenna

Connecting step-by-step

	Description
1.	Select Main Menu: Config...Interfaces... in the Leica software.
2.	Highlight SmartAntenna .
3.	EDIT (F3)
4.	CONFIGURE SmartAntenna Interface <Use Device: Yes> Select a free Bluetooth port.
5.	DEVCE (F5)
6.	CONFIGURE Devices Highlight ATX1230 GG .
7.	CONT (F1)
8.	SRCH (F4) to search for Bluetooth devices.
	 SmartAntenna must be turned on.
9.	CONFIGURE Search Bluetooth Device

	Description
	All available Bluetooth devices are displayed.
10.	Highlight the SmartAntenna to be used.
11.	CONT (F1)
	If the SmartAntenna selected is connected for the first time, a Windows CE authentication request comes up. Type in 0000 as identification number for Leica's Bluetooth and click OK .
	Once the Bluetooth connection is established, the Bluetooth LED on the SmartAntenna starts flashing in blue.

5 Local Mode

5.1 Accessing the Main Configuration Menu



This menu is always available to RX1210/RX1210T.

This menu is only available to the RX1250 models when in terminal mode.

Access

Press **USER** for 2 s or automatically after 10 s when no sensor can be detected.

A message is displayed for a period of 10 s.

Next step

IF the RX is to be	THEN
configured	CONF (F2) leads directly to Main Configuration Menu .
connected automatically	AUTO (F3) initiates the auto detect function. RX tries to connect to any available instrument or receiver.
connected to TPS	TPS (F4) tries to connect to any available TPS instrument.
connected to GPS	GPS (F5) tries to connect to any available GPS receiver.

5.2 Overview of the Main Configuration Menu

Main Configuration Menu

Description of main menu functions

Main menu function	Description	Refer to chapter
Choose Sensor	Select the sensor to be working with RX.	5.3
Local Settings	Change or adjust the display and sound settings of RX.	5.4
Radio/Comms Settings	Change or adjust the communication settings of RX.	5.5
Work with Sensor	Leave the Local Mode and work with the selected sensor.	5.6

5.3 Choosing a Sensor

Access step-by-step

	Description
1.	Refer to "5.1 Accessing the Main Configuration Menu" to access the menu
2.	Main Configuration Menu Highlight Choose Sensor .
3.	CONT (F1) .

Choose Sensor

Description of fields

Field	Option	Description
Sensor	TPS1200+/ TPS1200	Sets RX to work with TPS1200+/TPS1200. Choose this option if working only TPS1200+/TPS1200.
	GPS1200	Sets RX to work with GPS1200. Choose this option if working only GPS1200.
	Auto Detect	Sets RX to try and connect with any connected instrument when starting up. This is the default setting.

5.4 Local Settings

Description

The settings on this screen allow the screen appearance to be configured, turn the notification beeps on and off and define the behaviour of the keys. The settings are stored on RX itself.

Access step-by-step

	Description
1.	Refer to "5.1 Accessing the Main Configuration Menu" to access the menu
2.	Main Configuration Menu Highlight Local Settings .
3.	CONT (F1) .

Local Settings, Display page

Description of fields

Field	Option	Description
<Touch Screen:>	On or Off	Turns touch screen on and off.
<Screen Beep:>	Off , Soft or Loud	Controls the beep upon touching the touch screen.

Field	Option	Description
<Screen Illum:>	Off, Always On, On for 30 s, On for 1 min, On for 2 min or On for 5 min	Controls the screen illumination to be on, off or on for the specified time after the last key was pressed or touch screen event.
<Key Illum:>	Off, Always On, or Same as Screen	Controls the keyboard illumination.
<Contrast:>	From 0% to 100%	For RX1210/RX1210T only. Adjust the contrast level for the display using the arrow keys or using the stylus on the slider.
<Heating:>	Off Automatic	For RX1210/RX1210T only. The screen heating never comes on. The screen heating comes on automatically at 5°C and below and shuts off again at 7°C.
<Brightness:>	Settings from 1-5	For all RX1250 models only. To set the screen brightness.

Next step

IF	THEN
the local settings are to be exited	CONT (F1) accepts changes and returns to the screen from where this screen was accessed.
the touch screen is to be calibrated	CALIB (F5) calibrates the touch screen.
the next page is to be accessed	PAGE (F6) changes to another page.

Local Settings, Beeps page

Description of fields

Field	Option	Description
<Warning Beeps:>	Off, Soft or Loud	Controls the beep for acoustic warning signals.
<Key Beeps:>	Off, Soft or Loud	Controls the beep upon key presses on RX.

Local Settings,
More page

Description of fields

Field	Option	Description
<Language:>	Choicelist	Allows the local mode functions to be displayed in different languages. The language setting does not affect the language displayed when working with a sensor. When working with a sensor, the language selected in the sensor is shown on RX.
<Action:>	None RX Off RX+TPS Off	<p>RX does not switch off automatically.</p> <p>After the preset time of RX inactivity, RX switches off.</p> <p>After the preset time of RX inactivity, both RX and TPS1200+/TPS1200 switch off.</p>
<After time:>	From 1 to 99 minutes	Time of RX inactivity before the set action is executed.

5.5 Radio Settings

5.5.1 Radio Communication Settings

Description

Allows changes to the communication parameters of RX.

Access step-by-step

	Description
1.	Refer to "5.1 Accessing the Main Configuration Menu" to access the menu
2.	Main Configuration Menu Highlight Radio/Comms Settings .
3.	CONT (F1) .

Radio/Comms Settings, Modes page

Description of fields

Field	Option	Description
<ComMode:>	RCS Mode	RX operates as a secondary control unit for TPS1200+/TPS1200. This is the default setting of RX.

Field	Option	Description
	Transparent	Deactivates the software functionality of RX, converting it into a radio modem which can be used with GFU23, RadioHandle or TCPS27B to communicate remotely with TPS1200+/TPS1200. Refer to "4.9.3 Working in Transparent Mode" for more information.
	Semi-Transparent	Enables measurement data to be sent from TPS1200+/TPS1200, via the radio link, to the LEMO port of RX in real-time. RX continues to control TPS1200+/TPS1200 in the normal RCS way. Refer to "4.9.4 Working in Semi-Transparent Mode" for more information.
<Modem:>	Output	Communication internally via the radio modem or externally via the LEMO port.
<Baud Rate:>	From 19200 to 115200	This field is only available when: <ComMode: Transparent> or <ComMode: Semi-Transparent> .

Next step

IF	THEN
the local settings are to be exited	CONT (F1) accepts changes and returns to the screen from where this screen was accessed.
the next page is to be accessed	PAGE (F6) changes to another page on this screen

Radio/Comms Settings, Param page

Description of fields

Field	Option	Description
<Link Number:>	From 0 to 15	Assigned channel number enabling multiple pairs of radios to work simultaneously in the same area without interfering with each other. The link number for a pair of radios must be the same.
<Baud Rate:>	Output	Frequency of data transfer from instrument to device.
<Parity:>	Output	Error checksum at the end of a block of digital data.

Field	Option	Description
<Terminator:>	Output	The terminator of a data packet.
<Data Bits:>	Output	Number of bits in a block of digital data.
<Stop Bits:>	Output	Number of bits to end a block of digital data.
<Set as:>	Remote	Sets the internal radio into a remote mode. The radio modules inside GFU23, RadioHandle or TCPS27 and RX must be set to opposite settings. It is recommended to set RX to remote and the GFU23, RadioHandle or TCPS27 to base.
	Base	Sets the internal radio into a base mode



Next step

IF	THEN
the local settings are to be exited	CONT (F1) accepts changes and returns to the screen from where this screen was accessed.
default values are to be restored	DEFLT (F3) restores Leica default values to the internal modem of RX.

IF	THEN
radio settings are to be edited	EXT R (F4) displays and allows editing of TCPS27 external radio settings when connected to the LEMO port.
radio settings are to be synchronised	<p>SYNC (F5) synchronises the settings between the internal radio of RX and external radio GFU23, TCPS27B when connected to each other via cable.</p> <p> Open Radio/Comms Settings, Param page to change the parameters for the communication between the radios.</p>
the next page is to be accessed	PAGE (F6) changes to another page on this screen

5.5.2 Configuring the Radios

View/edit internal/external radio settings step-by-step

	Description
1.	Open Radio/Comms Settings, Param page.
2.	<ul style="list-style-type: none"> For RX1250T/RX1250Tc the internal radio settings are displayed. For other models the external radio settings are displayed, when a radio is connected.
	 DEFLT (F3) to reset to Leica default values
3.	Edit settings.
	 EXT R (F4) to view the external radio settings when a radio is connected to RX.
4.	CONT (F1) to exit and accept changes.
5.	ESC to exit and disregard changes.

Synchronising radio settings for the RX step-by-step

	Description
1.	Connect the radio to RX with a Y-cable and external battery.
2.	Open Radio/Comms Settings, Param page.

	Description
3.	SYNC (F5).
4.	Open Radio/Comms Settings, Param page.
5.	The settings of the internal radio of RX are displayed.
6.	Edit settings.

5.6 Working with a Sensor

Description

This function allows to leave the **Main Configuration Menu** and returns to working with the sensor.

Exit Configuring step-by-step

	Description
1.	ESC until Main Configuration Menu is displayed.
2.	Main Configuration Menu Highlight Work with Sensor .
3.	CONT (F1) .

6 Care and Transport

6.1 Transport

Transport in a road vehicle	Never carry the product loose in a road vehicle, as it can be affected by shock and vibration. Always carry the product in its transport container and secure it.
Shipping	When transporting the product by rail, air or sea, always use the complete original Leica Geosystems packaging, transport container and cardboard box, or its equivalent, to protect against shock and vibration.
Shipping, transport of batteries	When transporting or shipping batteries, the person in charge of the product must ensure that the applicable national and international rules and regulations are observed. Before transportation or shipping, contact your local passenger or freight transport company.

6.2 Storage

Product

Respect the temperature limits when storing the equipment, particularly in summer if the equipment is inside a vehicle. Refer to "9 Technical Data" for information about temperature limits.

Li-Ion batteries

- Refer to "9 Technical Data" for information about storage temperature range.
 - A storage temperature range of -20 to +30°C/-4 to 86°F in a dry environment is recommended to minimise self-discharging of the battery.
 - At the recommended storage temperature range, batteries containing a 10% to 50% charge can be stored for up to one year. After this storage period the batteries must be recharged.
 - Remove batteries from the product and the charger before storing.
 - After storage recharge batteries before using.
 - Protect batteries from damp and wetness. Wet or damp batteries must be dried before storing or use.
-

6.3 Cleaning and Drying

Product and accessories

Use only a clean, soft, lint-free cloth for cleaning. If necessary, moisten the cloth with water or pure alcohol. Do not use other liquids; these may attack the polymer components.

Damp products

Dry the product, the transport container, the foam inserts and the accessories at a temperature not greater than 40°C / 104°F and clean them. Do not repack until everything is completely dry. Always close the transport container when using in the field.

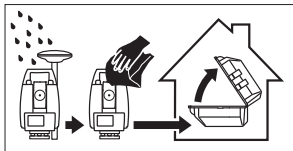

Cables and plugs

Keep plugs clean and dry. Blow away any dirt lodged in the plugs of the connecting cables.

7 Safety Directions

7.1 General Introduction

Description

The following directions should enable the person responsible for the product, and the person who actually uses the equipment, to anticipate and avoid operational hazards.

The person responsible for the product must ensure that all users understand these directions and adhere to them.

7.2 Intended Use

Permitted use

- Remote control of product.
 - Data communication with external appliances.
-

Adverse use

- Use of the product without instruction.
- Use outside of the intended limits.
- Disabling safety systems.
- Removal of hazard notices.
- Opening the product using tools, for example screwdriver, unless this is specifically permitted for certain functions.
- Modification or conversion of the product.
- Use after misappropriation.
- Use of products with obviously recognizable damages or defects.
- Use with accessories from other manufacturers without the prior explicit approval of Leica Geosystems.
- Inadequate safeguards at the surveying site, for example when measuring on roads.
- Controlling of machines, moving objects or similar monitoring application without additional control- and safety installations.

 **Warning**

Adverse use can lead to injury, malfunction and damage.

It is the task of the person responsible for the equipment to inform the user about hazards and how to counteract them. The product is not to be operated until the user has been instructed on how to work with it.

7.3 Limits of Use

Environment

Suitable for use in an atmosphere appropriate for permanent human habitation: not suitable for use in aggressive or explosive environments.



Danger

Local safety authorities and safety experts must be contacted before working in hazardous areas, or in close proximity to electrical installations or similar situations by the person in charge of the product.

7.4 Responsibilities

Manufacturer of the product

Leica Geosystems AG, CH-9435 Heerbrugg, hereinafter referred to as Leica Geosystems, is responsible for supplying the product, including the user manual and original accessories, in a completely safe condition.

Manufacturers of non Leica Geosystems accessories

The manufacturers of non Leica Geosystems accessories for the product are responsible for developing, implementing and communicating safety concepts for their products, and are also responsible for the effectiveness of those safety concepts in combination with the Leica Geosystems product.

Person in charge of the product

The person in charge of the product has the following duties:

- To understand the safety instructions on the product and the instructions in the user manual.
- To be familiar with local regulations relating to safety and accident prevention.
- To inform Leica Geosystems immediately if the product and the application becomes unsafe.
- To ensure that the national laws, regulations and conditions for the operation of radio transmitters are respected. Not applicable for RX1210.

 **Warning**

The person responsible for the product must ensure that it is used in accordance with the instructions. This person is also accountable for the training and the deployment of personnel who use the product and for the safety of the equipment in use.

7.5 End User Licence Agreement EULA

EULA terms

- You have acquired a device RX1250 that includes software licenced by Leica Geosystems from an affiliate of Microsoft Corporation ("MS"). Those installed software products of MS origin, as well as associated media, printed materials, and "online" or electronic documentation ("SOFTWARE") are protected by international intellectual property laws and treaties. The SOFTWARE is licensed, not sold. All rights reserved.
- IF YOU DO NOT AGREE TO THIS END USER LICENCE AGREEMENT ("EULA"), DO NOT USE THE DEVICE OR COPY THE SOFTWARE, INSTEAD, PROMPTLY CONTACT Leica Geosystems FOR INSTRUCTIONS ON RETURN OF THE UNUSED DEVICE(S) FOR A REFUND. **ANY USE OF THE SOFTWARE, INCLUDING BUT NOT LIMITED TO USE ON THE DEVICE, WILL CONSTITUTE YOUR AGREEMENT TO THIS EULA (OR RATIFICATION OF ANY PREVIOUS CONSENT).**
- **GRANT OF SOFTWARE LICENCE.** This EULA grants you the following licence:
 - You may use the SOFTWARE only on the DEVICE.
 - **NOT FAULT TOLERANT.** THE SOFTWARE IS NOT FAULT TOLERANT. Leica Geosystems HAS INDEPENDENTLY DETERMINED HOW TO USE THE SOFTWARE IN THE DEVICE, AND MS HAS RELIED UPON Leica

Geosystems TO CONDUCT SUFFICIENT TESTING TO DETERMINE THAT THE SOFTWARE IS SUITABLE FOR SUCH USE.

- **NO WARRANTIES FOR THE SOFTWARE.** THE SOFTWARE is provided "AS IS" and with all faults. THE ENTIRE RISK AS TO SATISFACTORY QUALITY, PERFORMNCE, ACCURACY, AND EFFORT (INCLUDING LACK OF NEGLIGENCE) IS WITH YOU. ALSO, THERE IS NO WARRANTY AGAINST INTERFERENCE WITH YOUR ENJOYMENT OF THE SOFTWARE OF AGAINST INFRINGEMENT. **IF YOU HAVE RECEIVED ANY WARRANTIES REGARDING THE DEVICE OR THE SOFTWARE, THOSE WARRANTIES DO NOT ORIGINATE FROM, AND ARE NOT BINDING ON, MS.**
- **No Liability for Certain Damages. EXCEPT AS PROHIBITED BY LAW, MS SHALL HAVE NO LIABILITY FOR ANY INDIRECT, SPECIAL, CONSEQUENTIAL OR INCIDENTAL DAMAGES ARISING FROM OR IN CONNECTION WITH THE USE OR PERFORMANCE OF THE SOFTWARE. THIS LIMITATION SHALL APPLY EVEN IF ANY REMEDY FAILS FOF ITS ESSENTIAL PURPOSE. IN NO EVENT SHALL MS BE LIABLE FOR ANY AMOUNT IN EXCESS OF U.S. TWO HUNDRED FIFTY DOLLARS (U.S.\$250.00).**
- **Limitations on Reverse Engineering, Decompilation, and Disassembly.** You may not reverse engineer, decompile, or disassemble the SOFTWARE,

except and only to the extent that such activity is expressly permitted by applicable law notwithstanding these limitation.

- **SOFTWARE TRANSFER ALLOWED BUT WITH RESTRICTIONS.** You may permanently transfer rights under this EULA only as part of a permanent sale or transfer of the Device, and only if the recipient agrees to this EULA. If the SOFTWARE is an upgrade, any transfer must also include all prior versions of the SOFTWARE.
 - **EXPORT RESTRICTIONS.** You acknowledge that SOFTWARE is subject to U.S. and European Union export jurisdiction. You agree to comply with all applicable international and national laws that apply to the SOFTWARE, including the U.S. Export Administration Regulations, as well as end-user, end-use and destination restrictions issued by U.S. and other governments. For additional information see <http://www.microsoft.com/exporting/>.
-

7.6 Hazards of Use

Warning

The absence of instruction, or the inadequate imparting of instruction, can lead to incorrect or adverse use, and can give rise to accidents with far-reaching human, material, financial and environmental consequences.

Precautions:

All users must follow the safety directions given by the manufacturer and the directions of the person responsible for the product.





Danger

Because of the risk of electrocution, it is very dangerous to use poles and extensions in the vicinity of electrical installations such as power cables or electrical railways.

Precautions:

Keep at a safe distance from electrical installations. If it is essential to work in this environment, first contact the safety authorities responsible for the electrical installations and follow their instructions.



-
-  **Warning** If the product is used with accessories, for example masts, staffs, poles, you may increase the risk of being struck by lightning.
- Precautions:**
Do not use the product in a thunderstorm.
-
-  **Warning** During dynamic applications, for example stakeout procedures there is a danger of accidents occurring if the user does not pay attention to the environmental conditions around, for example obstacles, excavations or traffic.
- Precautions:**
The person responsible for the product must make all users fully aware of the existing dangers.
-
-  **Warning** Inadequate securing of the working site can lead to dangerous situations, for example in traffic, on building sites, and at industrial installations.
- Precautions:**
Always ensure that the working site is adequately secured. Adhere to the regulations governing safety and accident prevention and road traffic.
-
-  **Caution** With the remote control on surveying products, it is possible that extraneous targets will be picked out and measured.
- Precautions:**
When measuring in remote control mode, always check your results for plausibility.

 **Warning**

Only Leica Geosystems authorized service workshops are entitled to repair these products.

 **Warning**

If computers intended for use indoors are used in the field there is a danger of electric shock.

Precautions:

Adhere to the instructions given by the computer manufacturer with regard to field use in conjunction with Leica Geosystems products.



 **Caution**

If the accessories used with the product are not properly secured and the product is subjected to mechanical shock, for example blows or falling, the product may be damaged or people may sustain injury.

Precautions:

When setting-up the product, make sure that the accessories are correctly adapted, fitted, secured, and locked in position.

Avoid subjecting the product to mechanical stress.

-
-  **Caution** During the transport, shipping or disposal of batteries it is possible for inappropriate mechanical influences to constitute a fire hazard.
- Precautions:**
Before shipping the product or disposing of it, discharge the batteries by running the product until they are flat.
When transporting or shipping batteries, the person in charge of the product must ensure that the applicable national and international rules and regulations are observed. Before transportation or shipping contact your local passenger or freight transport company.
-
-  **Warning** Using a battery charger not recommended by Leica Geosystems can destroy the batteries. This can cause fire or explosions.
- Precautions:**
Only use chargers recommended by Leica Geosystems to charge the batteries.
-
-  **Warning** High mechanical stress, high ambient temperatures or immersion into fluids can cause leakage, fire or explosions of the batteries.
- Precautions:**
Protect the batteries from mechanical influences and high ambient temperatures. Do not drop or immerse batteries into fluids.
-

 **Warning**

Short circuited battery terminals can overheat and cause injury or fire, for example by storing or transporting in pockets if battery terminals come in contact with jewelry, keys, metallized paper or other metals.

Precautions:

Make sure that the battery terminals do not come into contact with metallic objects.

 **Warning**

If the product is improperly disposed of, the following can happen:

- If polymer parts are burnt, poisonous gases are produced which may impair health.
- If batteries are damaged or are heated strongly, they can explode and cause poisoning, burning, corrosion or environmental contamination.
- By disposing of the product irresponsibly you may enable unauthorized persons to use it in contravention of the regulations, exposing themselves and third parties to the risk of severe injury and rendering the environment liable to contamination.

Precautions:



The product must not be disposed with household waste.

Dispose of the product appropriately in accordance with the national regulations in force in your country.

Always prevent access to the product by unauthorized personnel.

Product specific treatment and waste management information can be downloaded from the Leica Geosystems home page at <http://www.leica-geosystems.com/treatment> or received from your Leica Geosystems dealer.

7.7 Electromagnetic Compatibility EMC

Description

The term Electromagnetic Compatibility is taken to mean the capability of the product to function smoothly in an environment where electromagnetic radiation and electrostatic discharges are present, and without causing electromagnetic disturbances to other equipment.



Warning

Electromagnetic radiation can cause disturbances in other equipment.

Although the product meets the strict regulations and standards which are in force in this respect, Leica Geosystems cannot completely exclude the possibility that other equipment may be disturbed.



Caution

There is a risk that disturbances may be caused in other equipment if the product is used in conjunction with accessories from other manufacturers, for example field computers, personal computers, two-way radios, non-standard cables or external batteries.

Precautions:

Use only the equipment and accessories recommended by Leica Geosystems. When combined with the product, they meet the strict requirements stipulated by the guidelines and standards. When using computers and two-way radio, pay attention to the information about electromagnetic compatibility provided by the manufacturer.

 **Caution**

Disturbances caused by electromagnetic radiation can result in erroneous measurements.

Although the product meets the strict regulations and standards which are in force in this respect, Leica Geosystems cannot completely exclude the possibility that the product may be disturbed by very intense electromagnetic radiation, for example, near radio transmitters, two-way radios or diesel generators.

Precautions:

Check the plausibility of results obtained under these conditions.

 **Warning**

If the product is operated with connecting cables attached at only one of their two ends, for example external supply cables, interface cables, the permitted level of electromagnetic radiation may be exceeded and the correct functioning of other products may be impaired.

Precautions:

While the product is in use, connecting cables, for example product to external battery, product to computer, must be connected at both ends.

Radios or digital cellular phones

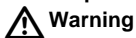

Use of product with radio or digital cellular phone:

Electromagnetic radiation can cause disturbances in other equipment, in installations, in medical devices, for example pacemakers or hearing aids and in aircraft. It can also affect humans and animals.

Precautions:

Although the product meets in combination with radio or digital cellular phone devices recommended by Leica Geosystems the strict regulations and standards which are in force in this respect, Leica Geosystems cannot completely exclude the possibility that other equipment may be disturbed or that humans or animals may be affected.

- Do not operate the product with radio or digital cellular phone devices in the vicinity of filling stations or chemical installations, or in other areas where an explosion hazard exists.
 - Do not operate the product with radio or digital cellular phone devices near medical equipment.
 - Do not operate the product with radio or digital cellular phone devices in aircraft.
 - Do not operate the product with radio or digital cellular phone devices for long periods immediately next to your body.
-

7.8 FCC Statement, Applicable in U.S.

Applicability

The grayed paragraph below is only applicable for RX1210 products without radio.

Warning

This equipment has been tested and found to comply with the limits for a Class B digital device, pursuant to part 15 of the FCC rules.

These limits are designed to provide reasonable protection against harmful interference in a residential installation.

This equipment generates, uses and can radiate radio frequency energy and, if not installed and used in accordance with the instructions, may cause harmful interference to radio communication. However, there is no guarantee that interference will not occur in a particular installation.

If this equipment does cause harmful interference to radio or television reception, which can be determined by turning the equipment off and on, the user is encouraged to try to correct the interference by one or more of the following measures:

- Reorient or relocate the receiving antenna.
- Increase the separation between the equipment and the receiver.
- Connect the equipment into an outlet on a circuit different from that to which the receiver is connected.
- Consult the dealer or an experienced radio/TV technician for help.

Warning

Changes or modifications not expressly approved by Leica Geosystems for compliance could void the user's authority to operate the equipment.

Labelling
RX1210/RX1210T

Type: RX1210
.....
.....
.....
.....
.....
.....
.....
.....
.....



CE

This device complies with part 15 of the FCC Rules. Operation is subject to the following two conditions: (1) This device may not cause harmful interference, and (2) this device must accept any interference received, including interference that may cause undesired operation.

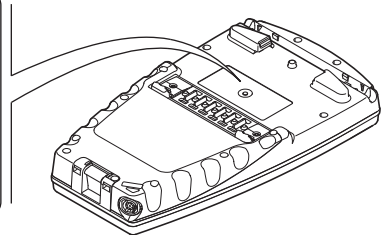
RX12_023



Labelling
all RX1250 models

<p>Type: RX1250</p> <p>.....</p> <p>.....</p> <p>.....</p> <p>.....</p> <p>.....</p>	<p><i>This device complies with part 15 of the FCC Rules. Operation is subject to the following two conditions: (1) This device may not cause harmful interference, and (2) this device must accept any interference received, including interference that may cause undesired operation.</i></p> <p style="text-align: center;">   </p>
--	--

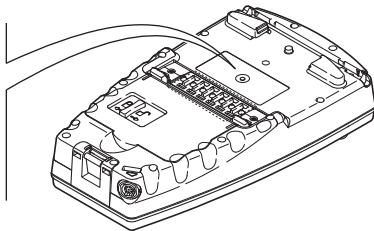

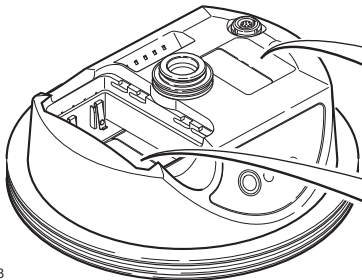

RX12_025

Labelling
SmartAntenna



This device complies with part 15 of the FCC Rules. Operation is subject to the following two conditions: (1) This device may not cause harmful interference, and (2) this device must accept any interference received, including interference that may cause undesired operation.

Type: AT...	Art.No.:
Equip.No.: XXXXXX	S.No.:
Power: 12V [±] , nominal 1/0.5A max.	
Leica Geosystems AG	
CH-9435 Heerbrugg	
Manufactured: 2004	 
Made in Switzerland	
S.No.:	

TPS12_208

Labelling GHT56

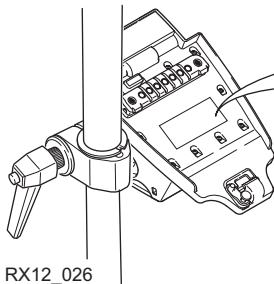

Type: GHT 56

.....
.....
.....
.....
.....
.....
.....



This device complies with part 15 of the FCC Rules. Operation is subject to the following two conditions: (1) This device may not cause harmful interference, and (2) this device must accept any interference received, including interference that may cause undesired operation.

Labelling
GFU23, GFU24

Type: GFUXX

.....

.....

.....

.....



.....

.....

.....

.....

.....



This device complies with part 15 of the FCC Rules. Operation is subject to the following two conditions: (1) This device may not cause harmful interference, and (2) this device must accept any interference received, including interference that may cause undesired

GPS12_103

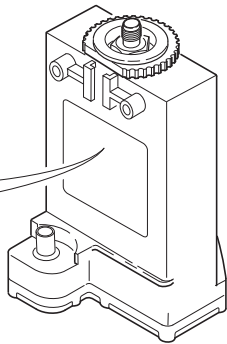

**Labelling
GFU19, GFU25,
GFU26**

Type: GFUXX

.....

.....

.....

.....

.....

.....

.....

.....

.....

.....



This device complies with part 15 of the FCC Rules. Operation is subject to the following two conditions: (1) This device may not cause harmful interference, and (2) this device must accept any interference received, including interference that may cause undesired operation.

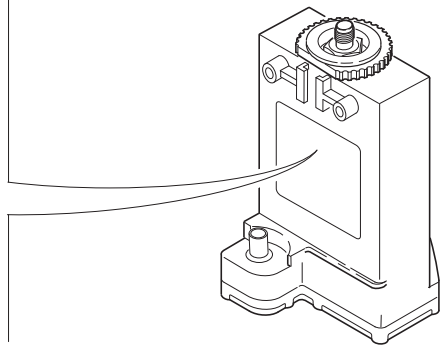

TPS12_218

Labelling
internal battery
GEB211, GEB221

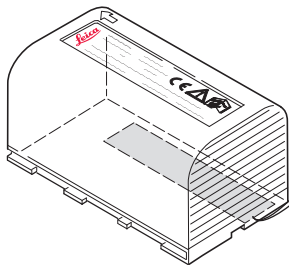

This device complies with part 15 of the FCC Rules. Operation is subject to the following two conditions: (1) This device may not cause harmful interference, and (2) this device must accept any interference received, including interference that may cause undesired operation.

 US LISTED
ITE Accessory
E179078 . 70YL

TPS12_082

Labelling USB cable GEV161

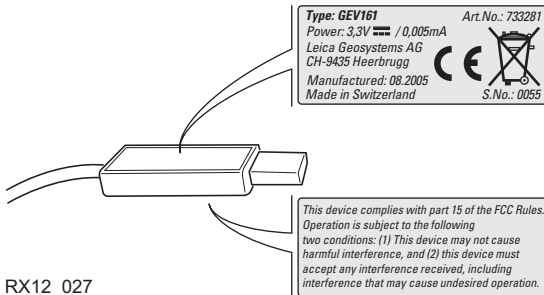

RX12_027

8 Trouble Shooting

Turning on and communicating with the instruments

Problem	Details	To be checked
RX does not turn on	all RX1250 models with a battery	<ul style="list-style-type: none">Battery fully charged.
	RX1210/RX1210T	<ul style="list-style-type: none">Clip-on connection to GPS1200.Cable connection to GPS1200 RX port.Connection to a fully charged battery.
RX does not connect to TPS1200+/TPS1200	Via the radio link	<ul style="list-style-type: none"><Sensor: TPS1200+> or <Sensor: Auto Detect> is selected in Main Configuration Menu: Choose Sensor on RX. Refer to "5.3 Choosing a Sensor".<ComMode: RCS Mode> is selected in Main Configuration Menu: Radio/Comms Settings on the Modes page. Refer to "5.5 Radio Settings".

Problem	Details	To be checked
		<ul style="list-style-type: none"> • TPS1200+/TPS1200 is set to work in RCS mode. Refer to TPS1200+/TPS1200 Technical Reference Manual. • The base radio is connected to the instrument and a fully charged external battery. • RX and the base radio are within radio range. • The radio settings in RX and the base radio are correct. Refer to "5.5 Radio Settings". Radio settings should be synchronised to Leica default values. Refer to paragraph "Synchronising radio settings for the RX step-by-step" in "5.5.2 Configuring the Radios".

Problem	Details	To be checked
	Via cable	<ul style="list-style-type: none">• <Sensor: TPS1200+> or <Sensor: Auto Detect> is selected in Main Configuration Menu: Choose Sensor on the controller. Refer to "5.3 Choosing a Sensor".• <ComMode: RCS Mode> is selected in Main Configuration Menu: Radio/Comms Settings on the Modes page. Refer to "5.5 Radio Settings".• Proper physical connection of cable to TPS1200+/TPS1200 and the controller.• RX1210/RX1210T is connected to the instrument and a fully charged external battery.
RX does not connect to GPS1200	Via clip-on-contacts	<ul style="list-style-type: none">• RX is properly connected to GPS1200.

Problem	Details	To be checked
	Via cable	<ul style="list-style-type: none"> • <Sensor: GPS1200> or <Sensor: Auto Detect> is selected in Main Configuration Menu: Choose Sensor on RX. Refer to "5.3 Choosing a Sensor". • RX is properly connected to GPS1200.
		<ul style="list-style-type: none"> • <Sensor: GPS1200> or <Sensor: Auto Detect> is selected in Main Configuration Menu: Choose Sensor on RX. Refer to "5.3 Choosing a Sensor".
RX1250 does not connect to SmartAntenna	Via Bluetooth Via cable	<ul style="list-style-type: none"> • SmartAntenna battery is charged. • SmartAntenna is switched on. • Correct configuration in CONFIGURE SmartAntenna Interface. • Correct cable being used GEV173, 8 pin Lemo connectors with green shielding.

Radio performance

Problem	Details	To be checked
Radio range not optimal		<ul style="list-style-type: none">• TCPS27B is mounted onto the tripod using the adapter. Refer to "3.1.4 Setting up for Remote Control (with the Radio-Handle)".• Change the link number if it is suspected to have other 2.4 GHz radios operating in the area, this measure may reduce interference and improve radio performance. Refer to "5.5 Radio Settings".• RX faces the instrument without obstruction between the antennas.

RX1250 communicating with radio/digital cellular phone

Problem	Details	To be checked
RX1250 does not connect to digital cellular phone	Via Bluetooth	<ul style="list-style-type: none">• Bluetooth on digital cellular phone turned on.• Digital cellular phone ready for external connectivity.

Problem	Details	To be checked
		<ul style="list-style-type: none"> Battery of digital cellular phone fully charged.
RX1250 does not recognise radio	Via GHT56	<ul style="list-style-type: none"> RX1250 is properly connected to GHT56 via clip-on-contacts. Battery of radio fully charged. The radio is powered by the battery attached to GHT56. If the LED indicator on GHT56 is green, then power is okay.

RX1250 recognising CompactFlash card

Problem	Details	To be checked
RX1250 does not recognise CompactFlash card	CompactFlash card is inserted into a slot inside the battery compartment on the underside of the RX1250.	<ul style="list-style-type: none"> CompactFlash card is inserted. CompactFlash card is pushed in completely.

**RX1250
Windows CE**

Problem	Details	To be checked
Icons not on Windows CE desktop	Icon to display Leica software	<ul style="list-style-type: none"> • Tap the Start button in the bottom left corner of Windows CE desktop. Then select Programs\Leica Geosystems. • Access the Windows directory from the Windows CE Explorer. Copy the Leica software icon and paste it to the Windows CE desktop. The Leica software icon may be a hidden file.
Function keys are hidden by Windows CE task bar	-	<ul style="list-style-type: none"> • Tap the Start button in the bottom left corner of Windows CE desktop. Then select Settings\Taskbar and Start Menu. Under the General tab tick the Auto hide option.

RX1250 Bluetooth connection to PC

Problem	Details	To be checked
RX1250 does not connect to PC	Via Bluetooth	<ul style="list-style-type: none"> • Use another USB port to connect the Bluetooth device to the PC.

Problem	Details	To be checked
		<ul style="list-style-type: none">• Is the device properly detected and the driver loaded?
		<ul style="list-style-type: none">• Go to My Computer/Manage/Device Management. Check the settings of the Bluetooth device.
		<ul style="list-style-type: none">• Check the Bluetooth device settings, for example the Options and COM ports pages.
		<ul style="list-style-type: none">• Is ActiveSync running? Is the correct COM port defined in the Connection Settings dialog?
		<ul style="list-style-type: none">• Re-boot the PC or/and RX1250.

9 Technical Data

9.1 RX Technical Data

Design Glass reinforced polymer housing with optional integrated battery and radio modem.

Control unit

Display: 1/4 VGA (320 x 240 pixels),
graphics capable LCD, illumination,
optional touch screen,
monochrome display (RX1210, RX1250T, RX1250X)
colour display (RX1250Tc, RX1250Xc)

Keyboard: 62 keys including 12 function keys, illumination

Angle Display: 360° , 360° decimal, 400 gon, 6400 mil, V %

Distance Display: m, ft int, ft us, ft int inch, ft us inch

Touch screen if fitted: Toughened film on glass

Dimensions

Type	Length [m]	Width [m]	Thickness [m]
RX1210/RX1210T	0.218	0.123	0.037
all RX1250 models	0.218	0.123	0.047

Weight

Type	Weight [kg]/[lbs]
RX1210/RX1210T	0.480/1.058
RX1250T/RX1250Tc, with GEB211, with Internal Radio	0.795/1.753
RX1250X/RX1250Xc, with GEB211	0.741/1.634

Recording

For all RX1250 models, data can be recorded on the CompactFlash card.

Type	Capacity [MB]	Data capacity
CompactFlash card	<ul style="list-style-type: none">• 256	256 MB is typically sufficient for about GPS only (8 satellites) <ul style="list-style-type: none">• 2000 h L1 + L2 data logging at 15 s rate• 8000 h L1 + L2 data logging at 60 s rate• 360000 real-time points with codes GPS + GLONASS (8 + 4 satellites) <ul style="list-style-type: none">• 1360 h data logging at 15 s rate• 5440 h data logging at 60 s rate• 360000 real-time points with codes

Power

Type	Consumption [W]	External supply voltage
RX1210/RX1210T	1	Nominal voltage 12 V DC (---) Voltage range 11.5 V-28 V
RX1250T/ RX1250Tc	1.6/ 1.8 Bluetooth to SmartAntenna, digital cellular phone powered from GHT56	Nominal voltage 12 V DC (---) Voltage range 11.5 V-28 V
RX1250X/ RX1250Xc	1.1/ 1.4 Bluetooth to SmartAntenna, digital cellular phone powered from GHT56	Nominal voltage 12 V DC (---) Voltage range 11.5 V-28 V

Internal battery

Type	Battery	Voltage	Capacity	Operating time, typical
RX1250T/ RX1250Tc	Li-Ion	7.4 V	GEB211: 2.2 Ah	10 h/ 9 h Radio link to instrument
RX1250X/ RX1250Xc	Li-Ion	7.4 V	GEB211: 2.2 Ah	12 h/ 11 h Bluetooth link to SmartAntenna

Environmental specifications

Temperature

Type	Operating temperature [°C]	Storage temperature [°C]
all models	-30 to +65 Bluetooth: -25 to +65 Colour display: -30 to +50	-40 to +80
Internal battery	-20 to +55	-40 to +70

Protection against water, dust and sand

Type	Protection
all models	IP67 (IEC60529) Dusttight Waterproof to 1 m temporary immersion

Humidity

Type	Protection
all models	Up to 100 % The effects of condensation are to be effectively counter-acted by periodically drying out RX.

Interfaces

Type	RS232 No handshake	RS232 Handshake	USB	Bluetooth
RX1210/RX1210T	LEMO port Clip-on-contacts	-	-	-
all RX1250 models	LEMO port	Clip-on-contacts	LEMO port	Class 2

**Data format for
RS232**

The default values are:

Baud rate: 115200
Parity: None
Terminator: CR/LF
Data bits: 8
Stop bits: 1

Ports

Type	8 pin LEMO-1	Special clip-on interface
all models	For power and/or communication	For communication to GHT56 and GPS1200

9.2 SmartAntenna Technical Data

9.2.1 Tracking Characteristics

Receiver technology SmartTrack+ (ATX1230 GG)

Satellite reception Dual frequency

Receiver channels ATX1230 GG: 14 channels continuous tracking on L1 and L2 (GPS); twelve channels continuous tracking on L1 and L2 (GLONASS); two channels tracking SBAS.

Supported codes **GPS**

Type	L1	L2
ATX1230 GG	Carrier phase, C/A code	Carrier phase, C code (L2C) and P2 code

GLONASS

Type	L1	L2
ATX1230 GG	Carrier phase, C/A code	Carrier phase, P2 code

Carrier tracking

GPS

Condition	ATX1230 GG
L1, AS off or on	Reconstructed carrier phase via C/A code
L2, AS off	Reconstructed carrier phase via P2 code
L2, AS on	Switches automatically to patented P code-aided technique providing full L2 reconstructed carrier phase

GLONASS

Condition	ATX1230 GG
L1	Reconstructed carrier phase via C/A code
L2	Reconstructed carrier phase via P2 code

Code measurements

GPS

Condition	ATX1230 GG
L1, AS off L1, AS on	Carrier phase smoothed code measurements: C/A code
L2, AS off	Carrier phase smoothed code measurements: P2 code
L2, AS on	Carrier phase smoothed code measurements: Patented P code-aided code

GLONASS

Condition	ATX1230 GG
L1	Carrier phase smoothed code measurements: C/A code
L2	Carrier phase smoothed code measurements: P2 code



Carrier phase and code measurements on L1 and L2 are fully independent with AS on or off.

Satellites tracked

ATX1230 GG: Up to 14 simultaneously on L1 and L2 (GPS) + up to 12 simultaneously on L1 and L2 (GLONASS) + up to 2 SBAS

9.2.2 Accuracy



Accuracy is dependent upon various factors including the number of satellites tracked, constellation geometry, observation time, ephemeris accuracy, ionospheric disturbance, multipath and resolved ambiguities.

The following accuracies, given as **root mean square**, are based on measurements processed using LGO and on real-time measurements.

Differential code

The baseline precision of a differential code solution for static and kinematic surveys is 25 cm.

Differential phase in post-processing

Static		Kinematic	
Horizontal	Vertical	Horizontal	Vertical
5 mm + 0.5 ppm	10 mm + 0.5 ppm	10 mm + 1 ppm	20 mm + 1 ppm

Differential phase in real-time

Static		Kinematic	
Horizontal	Vertical	Horizontal	Vertical
5 mm + 0.5 ppm	10 mm + 0.5 ppm	10 mm + 1 ppm	20 mm + 1 ppm

9.2.3 Technical Data

Description and use

The SmartAntenna is selected for use based upon the application. The table gives a description and the intended use of the SmartAntenna.

Type	Description	Use
ATX1230 GG	L1/L2 SmartTrack+ antenna with built in groundplane.	With RX1250 or TPS1200+/TPS1200.

Dimensions

Height: 0.089 m
Diameter: 0.186 m

Connector

8 pin LEMO-1

Mounting

5/8" Whitworth

Weight

1.1 kg including internal battery GEB211

Power

Power consumption: 1.8 W typically, 150 mA
External supply voltage: Nominal 12 V DC (---), voltage range 5-28 V DC

Battery internal

Type:	Li-Ion
Voltage:	7.4 V
Capacity:	GEB211: 2.2 Ah
Typical operating time:	5.7 h

Electrical data

Type	ATX1230 GG
Voltage	-
Current	-
Frequency	GPS L1 1575.42 MHz GPS L2 1227.60 MHz GLONASS L1 1602.5625-1611.5 MHz GLONASS L2 1246.4375-1254.3 MHz
Gain	Typically 27 dBi
Noise Figure	Typically < 2 dBi
BW, -3 dBiW	-
BW, -30 dBi	-

Environmental specifications**Temperature**

Operating temperature [°C]	Storage temperature [°C]
-40 to +65 Bluetooth: -30 to +65	-40 to +80

Protection against water, dust and sand

Protection
IP67 (IEC 60529) Dusttight Protected against water jets Waterproof to 1 m temporary immersion

Humidity

Protection
Up to 100 %

Protection

The effects of condensation are to be effectively counteracted by periodically drying out the antenna.

9.3 GHT56 Technical Data

Dimensions

Length:	0.169 m
Width:	0.123 m
Thickness:	0.130 m

Connector

- 8 pin LEMO-1
 - 7 pin clip-on-contacts
-

Weight

0.460 kg including internal battery GEB211

Power

Power consumption: Nominal voltage 7.4 V DC (---) / 2.0 A max

Battery

Type:	Li-Ion
Voltage:	7.4 V
Capacity:	GEB211: 2.2 Ah, GEB221: 4.4 Ah
Typical operating time:	The given operating times are valid for <ul style="list-style-type: none">• one fully charged GEB221 battery.• 25°C. Operating times will be shorter when working in cold weather.• good data link.

GFU14, receive only mode: 16.8 h
GFU24: 7.1 h
Pacific Crest radio, receive only mode: 15.4 h

Environmental specifications

Temperature

Operating temperature [°C]	Storage temperature [°C]
-20°C to +65	-40 to +80

Protection against water, dust and sand

Protection
IP67 (IEC 60529)
Dusttight
Protected against water jets
Waterproof to 1 m temporary immersion

Humidity

Protection
Up to 100 % The effects of condensation are to be effectively counteracted by periodically drying out the antenna.

9.4 Conformity to National Regulations

9.4.1 RX1210

Conformity to national regulations



Hereby, Leica Geosystems AG, declares that the product RX1210 is in compliance with the essential requirements and other relevant provisions of the applicable European Directives. The declaration of conformity may be consulted at <http://www.leica-geosystems.com/ce>.

9.4.2 RX1250, GFU23

Conformity to national regulations

- FCC Part 15 (applicable in US)
- Hereby, Leica Geosystems AG, declares that the RX1250 and GFU23 is in compliance with the essential requirements and other relevant provisions of Directive 1999/5/EC. The declaration of conformity may be consulted at <http://www.leica-geosystems.com/ce>.



- Class 1 equipment according European Directive 1999/5/EC (R&TTE) can be placed on the market and be put into service without restrictions in any EU Member state.
- The conformity for countries with other national regulations not covered by the FCC part 15 or European directive 1999/5/EC has to be approved prior to use and operation.

Frequency band

Type	Frequency band [MHz]
all RX1250 models (Bluetooth)	2402 - 2480
RX1250T/RX1250Tc (Spread Spectrum Transceiver)	Limited to 2409 - 2435
GFU23 (Spread Spectrum Transceiver)	

Output power

Type	Output power [mW]
all RX1250 models (Bluetooth)	2.5
RX1250T/RX1250Tc (Spread Spectrum Transceiver)	< 100
GFU23 (Spread Spectrum Transceiver)	

Antenna

Type A: all RX1250 models (Bluetooth)
Type B: RX1250T/RX1250Tc (Spread Spectrum Transceiver)
Type C: GFU23 (Spread Spectrum Transceiver)

Type	Antenna	Gain [dBi]	Connector	Frequency band [MHz]
A	Integrated antenna	-	-	-
B	Detachable $\lambda/4$ antenna	2	SMA	2409 - 2435
C	Detachable $\lambda/2$ antenna	1	TNC	2409 - 2435

9.4.3 GFU24, Siemens MC75

Conformity to national regulations

- FCC Part 15, 22 and 24 (applicable in US)
- Hereby, Leica Geosystems AG, declares that the GFU24 is in compliance with the essential requirements and other relevant provisions of Directive 1999/5/EC. The declaration of conformity may be consulted at <http://www.leica-geosystems.com/ce>.



Class 1 equipment according European Directive 1999/5/EC (R&TTE) can be placed on the market and be put into service without restrictions in any EU Member state.

- The conformity for countries with other national regulations not covered by the FCC part 15, 22 and 24 or European directive 1999/5/EC has to be approved prior to use and operation.

Frequency band

Quad-Band EGSM850 / EGSM900 / GSM1800 / GSM1900 MHz

Output power

EGSM850:	2 W
EGSM900:	2 W
GSM1800:	1 W
GSM1900:	1 W

Antennas

Type	GAT 3	GAT 5
Frequency band	900 or 1800 MHz	850 or 1900 MHz
Type	Detachable $\lambda/2$ antenna	Detachable $\lambda/2$ antenna
Gain	0 dBi	0 dBi
Connector	TNC	TNC

Specific Absorption Rate (SAR)

The product meets the limits for the maximum permissible exposure of the guidelines and standards which are force in this respect. The product must be used with the recommended antenna. A separation distance of at least 20 centimeters should be kept between the antenna and the body of the user or nearby person within the intended application.

9.4.4 GFU19 (US), GFU25 (CAN), GFU26 (US) CDMA MultiTech MTMMC-C

Conformity to national regulations

- FCC Part 15, 22 and 24 (applicable in US)
- The conformity for countries with other national regulations not covered by the FCC part 15, 22 and 24 has to be approved prior to use and operation.

Frequency band

Dual-Band CDMA850/CDMA1900 MHz

Output power

CDMA850: 2 W
CDMA1900: 0.4 W

Antenna

Type	GAT 5
Frequency band	850 or 1900 MHz
Type	Detachable $\lambda/2$ antenna
Gain	0 dBi
Connector	TNC

Specific Absorption Rate (SAR)

The product meets the limits for the maximum permissible exposure of the guidelines and standards which are force in this respect. The product must be used with the recommended antenna. A separation distance of at least 20 centimeters should be kept between the antenna and the body of the user or nearby person within the intended application.

9.4.5 SmartAntenna with Bluetooth

Conformity to national regulations

- FCC Part 15 (applicable in US)
- Hereby, Leica Geosystems AG, declares that the SmartAntenna with Bluetooth is in compliance with the essential requirements and other relevant provisions of Directive 1999/5/EC. The declaration of conformity may be consulted at <http://www.leica-geosystems.com/ce>.



- Class 1 equipment according European Directive 1999/5/EC (R&TTE) can be placed on the market and be put into service without restrictions in any EU Member state.
- The conformity for countries with other national regulations not covered by the FCC part 15 or European directive 1999/5/EC has to be approved prior to use and operation.

Frequency band

Type	Frequency band [MHz]
ATX1230 GG	1227.60 1575.42
ATX1230 GG	1246.4375 - 1254.3 1602.4375 - 1611.5
Bluetooth	2402 - 2480

Output power

Type	Output power [mW]
GNSS	Receive only
Bluetooth	5

Antenna

GNSS	Internal GNSS antenna element (receive only)
Bluetooth	Type: Internal Microstrip antenna Gain: 1.5 dBi

10 International Limited Warranty, Software Licence Agreement

International Limited Warranty

This product is subject to the terms and conditions set out in the International Limited Warranty which you can download from the Leica Geosystems home page at <http://www.leica-geosystems.com/internationalwarranty> or collect from your Leica Geosystems distributor. The foregoing warranty is exclusive and is in lieu of all other warranties, terms or conditions, express or implied, either in fact or by operation of law, statutory or otherwise, including warranties, terms or conditions of merchantability, fitness for a particular purpose, satisfactory quality and non-infringement, all of which are expressly disclaimed.

Software Licence Agreement

This product contains software that is preinstalled on the product, or that is supplied to you on a data carrier medium, or that can be downloaded by you online pursuant to prior authorization from Leica Geosystems. Such software is protected by copyright and other laws and its use is defined and regulated by the Leica Geosystems Software Licence Agreement, which covers aspects such as, but not limited to, Scope of the Licence, Warranty, Intellectual Property Rights, Limitation of Liability, Exclusion of other Assurances, Governing Law and Place of Jurisdiction. Please make sure, that at any time you fully comply with the terms and conditions of the Leica Geosystems Software Licence Agreement.

Such agreement is provided together with all products and can also be referred to and downloaded at the Leica Geosystems home page at <http://www.leica-geosystems.com/swlicense> or collected from your Leica Geosystems distributor.

You must not install or use the software unless you have read and accepted the terms and conditions of the Leica Geosystems Software Licence Agreement. Installation or use of the software or any part thereof, is deemed to be an acceptance of all the terms and conditions of such licence agreement. If you do not agree to all or some of the terms of such licence agreement, you may not download, install or use the software and you must return the unused software together with its accompanying documentation and the purchase receipt to the dealer from whom you purchased the product within ten (10) days of purchase to obtain a full refund of the purchase price.

Appendix A Directory Structure of the Memory Device

Description

On the memory device, files are stored in certain directories. The following diagram of the directory structure refers to both CompactFlash card and internal memory if fitted. Backwards compatible with Leica GPS System 500 are geoid field files, CSCS field files and GSI files.

Directory structure

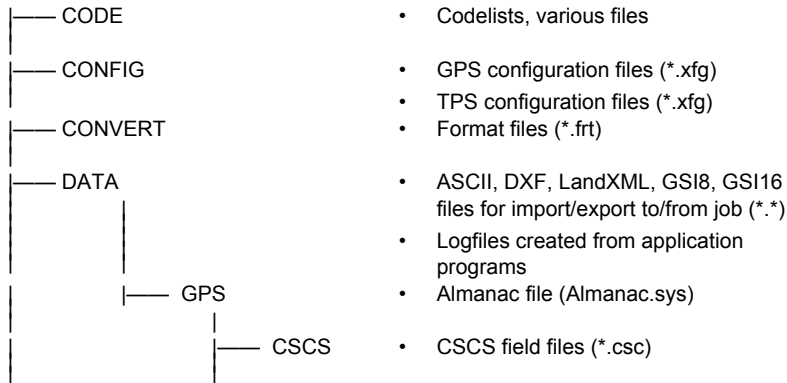

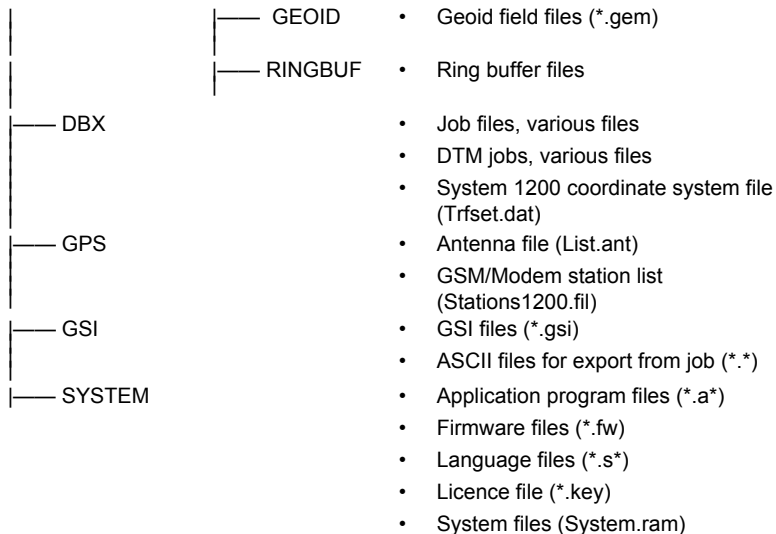

Appendix B Cables

Description

Some applications require the connection of instruments, devices or accessories to the RX. In this chapter, the required cables and their use are listed.

Cables connecting instruments, devices or accessories

The table shows in alphabetical order which instruments, devices or accessories can be connected using cables. Refer to paragraph "Cables and product names" for a full description of these cables.

From	To	Cables
External - GEB171 or GEV208	all RX1250 models	• GEV215
	SmartAntenna	• GEV215
PC cable, RS232 9 pin	all RX1250 models	• GEV162
	SmartAntenna	• GEV162
PC cable, USB on PC	all RX1250 models	• GEV161
RX1210/RX1210T	GPS1200	• GEV163
		• GEV164

From	To	Cables
	GRX1200 Pro/ GRX1200 GG Pro	<ul style="list-style-type: none"> • GEV163 • GEV164
RX1250 (all RX1250 models)	SmartAntenna	<ul style="list-style-type: none"> • GEV173 • GEV215
	TPS1200+/ TPS1200	<ul style="list-style-type: none"> • GEV217
TCPS27	TPS1200+/ TPS1200	<ul style="list-style-type: none"> • GEV186

Cables and product names

The product names of the cables in the above table are explained in detail below in ascending order.

Name	Description
GEV71	Cable 4.0 m, LEMO to 12 V DC power supply It allows a connection to a 12 V DC power supply for example a car battery. Cables used to connect to a GEB171 battery can be connected to adapter cable number 7.
GEV97	Cable 1.8 m, GX power cable

Name	Description
GEV160	Cable 2.8 m, data transfer GX COM to RS232
GEV161	Cable 2.8 m, data transfer GX RX1250 to USB
GEV162	Cable 2.8 m, data transfer GX RX to RS232
GEV163	Cable 1.8 m, RX to GX
GEV164	Cable 1.0 m, RX to GX, all-on-pole setup
GEV171	Y-cable 1.8 m, programming cable, GFU14 to RS232 with power
GEV173	Cable 1.2 m, SmartAntenna to all RX1250 models
GEV186	Y-cable 1.8 m, TCPS27 to TPS1200+/TPS1200 with power
GEV208	Power supply unit, 12 V DC
GEV215	Y-cable, SmartAntenna and all RX1250 models to GEB171
GEV217	Cable 1.8 m, TPS1200+/TPS1200 to all RX1250 models

Index

A

Abbreviations	12
ActiveSync	18, 101
Antenna file, directory	197
Application program file, directory	197
Attach, clip-on-housing	71

B

Battery

Change in GHT56	60
Change in RX1250	56
Change in SmartAntenna	58
Icons	33
Operating temperature	171
Storage temperature	131, 171

Bluetooth

Icon	34
LED on SmartAntenna	66

C

Cables	198
Cleaning and Drying	132
Clip-on-housing	
Attach	71
Detach	72
Codelist, directory	196
CompactFlash card	
Format	64
Insert	63
Memory device	19
Remove	63
Safety instructions	62
Configuration file, directory	196
Connector	
GHT56	182
SmartAntenna	178
Conversion of data	20

Coordinate system file, directory	197	Environmental specifications	
CSCS field file, directory	196	GHT56	183
D		SmartAntenna	180
Data conversion	20	EULA	140
Data transfer	20	F	
Detach, clip-on-housing	72	Firmware file, directory	197
Device		Flashing LED on clip-on-housing	79
Clip-on-housing	70	Format CompactFlash card	64
Status	77	Format files, directory	196
Dimensions		Frequency band	
GHT56	182	GFU19, MultiTech MTMMC-C	190
SmartAntenna	178	GFU24, Siemens MC75	188
Directory structure of memory device	196	SmartAntenna	192
Documentation	4	G	
Drive		GAT 3, antenna	189
PC card, on office computer	20	GeoC++	17
DTM job, directory	197	Geoid field file, directory	197
E		GFU19	190
Electrical data, SmartAntenna	179	GFU23	186
End User Licence Agreement	140	GFU24	188

GFU25	190	K	
GFU26	190	Key Combinations	29
GSI file, directory	197	Keyboard	
H		Graphical overview	26
Handstrap	43	Operating principles	32
Housing for devices	70	Keys	
I		Alpha keys	27
Icons	33	Arrow keys	28
Indicators, LED		CAPS key	27
Clip-on-housing	77	CE key	27
GHT56	68	Combinations	29
SmartAntenna	66	Description of	27
Insert		ENTER key	28
CompactFlash card	63	ESC key	27
SIM card	73	Function keys	27
J		Hot keys	27
Job file, directory	197	Numeric keys	27
		PROG key	28
		SHIFT key	28
		SPACE key	28
		USER key	28

L

Labelling

GHT56	155
RX1210	153
RX1250	154
USB cable GEV161	159

Language file, directory	197
--------------------------------	-----

LED

Clip-on-housing, description	78
GHT56, description	69
Housing, description	77
SmartAntenna, description	67

Licence file, directory	197
-------------------------------	-----

Light Emitting Diode

Clip-on-housing	77
GHT56	68
SmartAntenna	66

Li-Ion battery	179, 182
----------------------	----------

Local Settings	117
----------------------	-----

Logfile, directory	196
--------------------------	-----

M

Main Configuration Menu

Accessing	114
Choosing a sensor	116
Description of	115
Local settings	117

Memory device

Available	19
Directory structure	196

Microsoft ActiveSync	18, 101
----------------------------	---------

Mode

Remote	108
Semi-transparent	110
Transparent	109

Mount, SmartAntenna	178
---------------------------	-----

MultiTech MTMMC-C

GFU19, technical data	190
-----------------------------	-----

O

Operating Temperature

For internal battery GEB211	171
-----------------------------------	-----

For RX	171	Communication settings	121
GHT56	183	Configuring	126
SmartAntenna	180	Description of RadioHandle	14
Output power		Description of TCPS27	14
GFU19, MultiTech MTMMC-C	190	Mount TCPS27 to tripod	48
GFU24, Siemens MC75	188	RCS setup with RadioHandle	46
SmartAntenna	193	RCS setup with TCPS27	47
P		RadioHandle, description of	14
PC card drive on office computer	20	RCS	
Power		Setup with RadioHandle	46
GHT56	182	Setup with TCPS27	47
SmartAntenna	178	Recording	169
Power LED		Remove	
GHT56	68	CompactFlash card	63
SmartAntenna	66	SIM card	75
Power on GHT56, status	68	Ring buffer file, directory	197
Power supply	21	RX	
R		Available models	13
Radio Modem		Components	24
Available radios	14	Description of	12
		Detach from GPS receiver	45

Detach from pole	42	SmartAntenna	
Firmware for all RX1250 models	15	Accuracy	177
Firmware for RX1210/RX1210T	15	Battery	21
Operating principles	32	Status	66
Operating temperature	171	Technical data	174
Storage temperature	171	Software	
S		Application programs	16
Screen		ATX1230 GG	17
Description of elements	30	Customised application programs	17
Graphical overview	30	Language	16
Icons	33	Type	15
Setup for RCS		Upload	17
With RadioHandle	46	Specifications, environmental	
With TCPS27	47	GHT56	183
Siemens MC75		SmartAntenna	180
GFU24, technical data	188	Status, device	77
SIM card		Status, power on GHT56	68
Insert	73	Status, SmartAntenna	66
Remove	75	Storage of Equipment	131
Sleep mode	88	Storage Temperature	
		For internal battery GEB211	131, 171

For RX	171	Transport of Equipment	130
GHT56	183	Trouble Shooting	160
SmartAntenna	180	Turning the RX off	29, 86
System file, directory	197	Turning the RX on	28, 83
T		U	
TCPS27, description of	14	Upload software	17
Technical Data		User Interface	26
Dimensions	168	User Manual	
Display and keyboard	168	Validity of	4
Environmental specifications	171	W	
Interface	172	Weight	
Internal battery GEB211	171	GHT56	182
Ports	173	SmartAntenna	178
Power supply	170	Windows key symbol	26, 29
Weight	169		
Temperature, charging internal battery	54		
Touch Screen, operating principles	32		
Tracking LED, SmartAntenna	66		
Transfer data	20		
Transparent Mode	109		

Total Quality Management: Our commitment to total customer satisfaction.



Leica Geosystems AG, Heerbrugg, Switzerland, has been certified as being equipped with a quality system which meets the International Standards of Quality Management and Quality Systems (ISO standard 9001) and Environmental Management Systems (ISO standard 14001).

Ask your local Leica Geosystems dealer for more information about our TQM program.

Leica Geosystems AG
Heinrich-Wild-Strasse
CH-9435 Heerbrugg
Switzerland
Phone +41 71 727 31 31
www.leica-geosystems.com

- when it has to be **right**

Leica
Geosystems